



A Publication for the
Radio Amateur Worldwide

Especially Covering VHF,
UHF and Microwaves

VHF COMMUNICATIONS

Volume No.28 . Winter . 1/1996 . £4.50

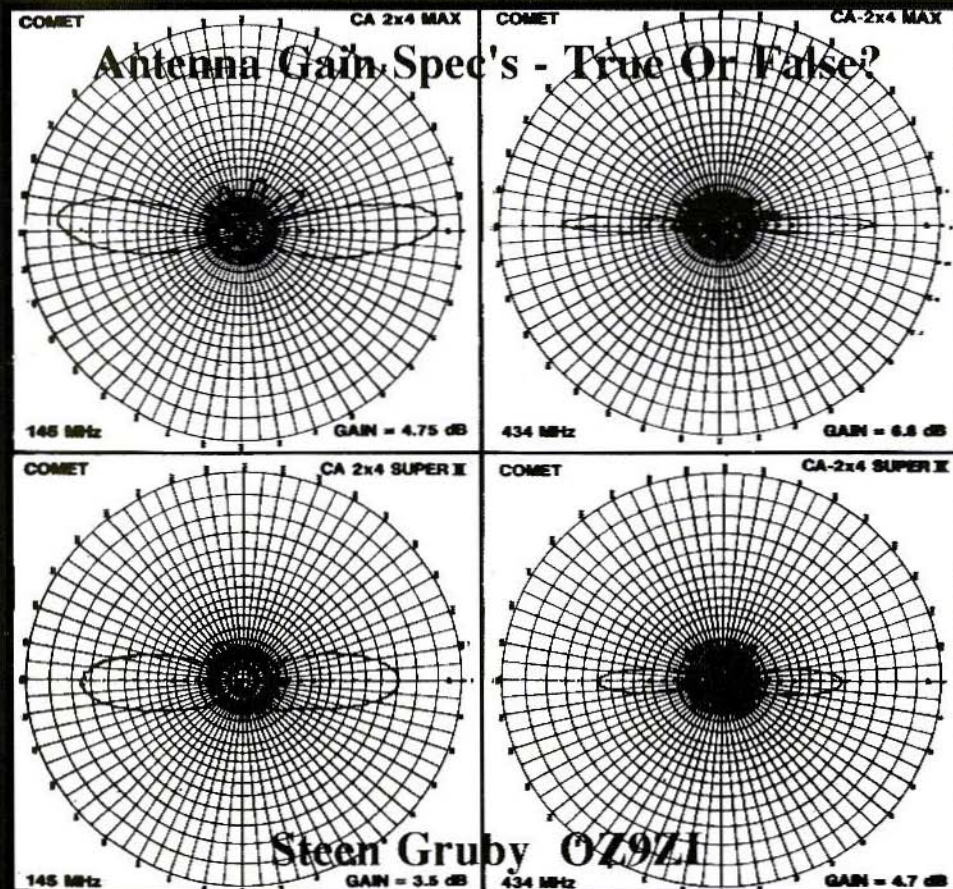

Steen Gruby OZ9LI

DESIGN OSCILLATORS & FILTERS

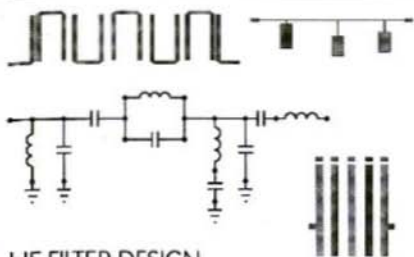

HF FILTER DESIGN AND COMPUTER SIMULATION

This book is packed with invaluable information on the practical design of L-C and distributed (both printed and machined) filters.

- ✓ Great collection of lumped and line models
- ✓ Simple, narrow and special bandpass
- ✓ Zig-zag and other elliptic types
- ✓ Equivalent circuit transformations
- ✓ End, edge and direct coupled
- ✓ Hairpin, combine and interdigital
- ✓ Group delay equalization
- ✓ Computer aided techniques
- ✓ Photographs and measured responses



428 Pages
180 Figures
62 Tables
301 Equations

\$59

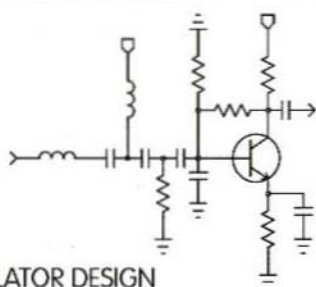

OSCILLATOR DESIGN AND COMPUTER SIMULATION

Contains easy-to-understand oscillator theory and practical tips and techniques for L-C, transmission line, SAW and crystal oscillators. Some of the topics are:

- ✓ Easy-to-understand design goals
- ✓ L-C, 1-line, crystal and SAW resonators
- ✓ Bipolar and JFET amplifiers
- ✓ Starting characteristics
- ✓ Noise performance
- ✓ VCOs
- ✓ Pulling crystal oscillators
- ✓ Linear and non-linear computer analysis
- ✓ Lots of examples



300 Pages
136 Figures
27 Tables
275 Equations

\$64

Name _____
Company _____
Address _____
City _____ State _____
ZIP _____ Country _____
Phone _____ FAX _____
Card # _____ Exp _____
Signature _____

Please send the following products

- Oscillator Design \$64
 HF Filter Design \$59
 Both Books \$99

Shipping & Handling
United States \$ 5
International Air \$20

- Payment Method
 VISA or MASTERCARD
 EuroCheck
 Bank Check (Must have the name of a US bank on the check)

NOBLE PUBLISHING

2245 Dillard Street TEL (404)908-2320
Tucker, GA 30084 USA. FAX (404)939-0157



Contents

Eugen Berberich DL8ZX	Easily Assembled UHF - VHF Antennas for the Radio Amateur	2 - 9
Steen Gruby OZ9ZI	Reliability of Gain Specifications for Antennas	10 - 19
Richard A. Formato K1POO	Improved Impedance Loading for Wideband Antennas	20 - 29
Index of Volume 27 (1995)		31 - 34
Dipl.-Ing.Detlef Burchard	Linear Signal Rectification Part-3 (conclusion)	35 - 41
Richard A. Formato K1POO	Design Parameters for Impedance Loaded Wideband Antennas	42 - 54
Michael J. Wooding G6IQM	Filtech Professional <i>A Review</i>	55 - 61



KM Publications, 5 Ware Orchard, Barby, Rugby, CV23 8UF, UK

Telephone: (0)1788 890365; INT: +44 1788 890365; FAX: (0)1788 891883
INTERNET: vhf-comm@g6iqm.demon.co.uk COMPUSERVE: 100441,377
WWW <http://www.eolas.co.uk/ag/vhfcomm.htm>

Eugen Berberich, DL 8 ZX

Easily Assembled UHF - VHF Antennas for the Radio Amateur

Radio amateurs are often faced with the question of whether to buy antennas for special purposes ready-made or make them themselves.

1. INTRODUCTION

Standard antennas for the VHF - UHF bands are available at reasonable prices, so there is little to be gained by building your own. It's a different matter if you're looking for antennas with special characteristics. For example, anyone who wants antennas for beacons or transponders with omnidirectional characteristics will often fail to find them on the market. Home-made antennas can be of assistance here, using materials from builders' markets or from domestic shops. Anyone with some talent for handicrafts can thus construct effective

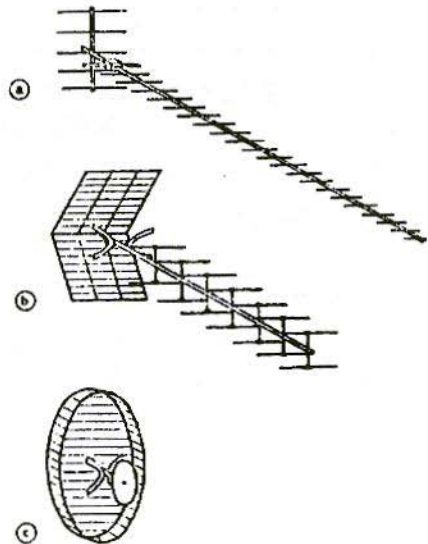

Fig.1: Comparison of Three Different Types of Antenna with Same Gain
 a Yagi Antenna
 b Quadruple Yagi Antenna
 c Short Backfire Antenna

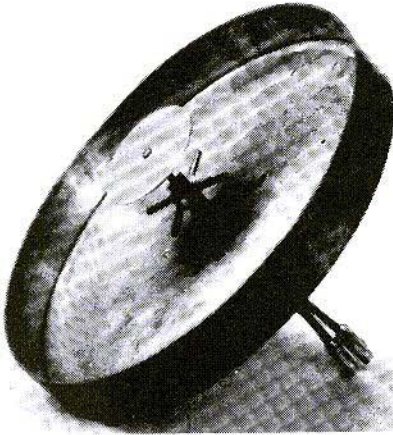

Fig.2: Short Backfire Antenna with Cross Dipole

antennas at a reasonable cost. For directional antennas for GHz bands as well, home-made equipment can often yield better results than those obtained by comparable industrial products.

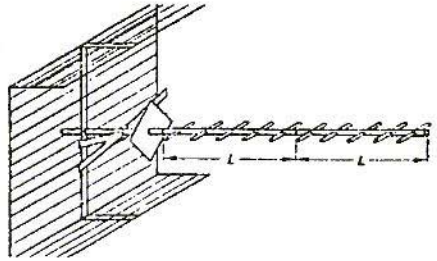

Fig.3: Short Backfire Alignment Array for 450 to 850 MHz

2. DIRECTIONAL ANTENNAS FOR 13cm

As a first example, I'd like to describe an antenna with directional characteristics for the 13cm band. It is considerably easier to make than a long Yagi, as it doesn't have the many elements of a Yagi with precise but varying lengths.

With regard to the short element

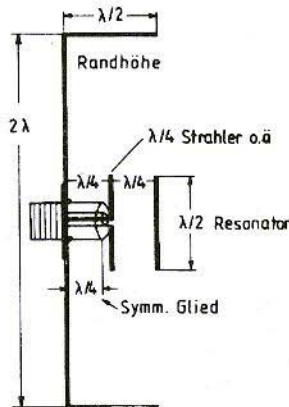
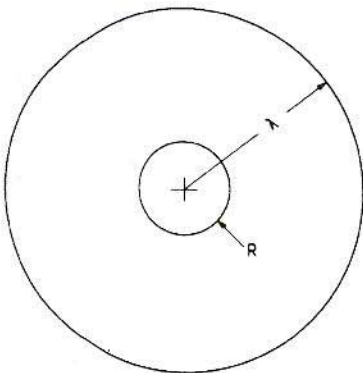

Fig.4: Outline Structure of a Short Backfire Antenna
Randhöhe = Edge height; *Strahler o.ä* = Radiator or similar;
Symm. Glied = Symmetrical parts

lengths, attention should also be paid to the boom, which accounts for a large part of the length of the elements of UHF / VHF "Yagi" antennas. Here we are dealing with a short-backfire antenna, with somewhat less gain than a long Yagi. Publications [1 to 7] provided the basic information for this antenna.

This antenna is very narrow-band and so has not been used much in the entertainment electronics industry, but it can be used to great effect in the amateur radio field. Above all, the use of a broader-band radiator, as described

by DL7KM in relation to hybrid antennas [8], means this antenna is very suitable for GHz bands. Moreover, parasitic interference is also possible in an enlarged resonator body [1].

In an earlier construction project, I made the resonator back from epoxy resin printed circuit board material and the collar from a strip, which was soldered on. So the assembly required quite a lot of expense! However, this form of antenna still required a lot of construction, so I pondered on a simpler construction. While out shopping in the household equipment department of a

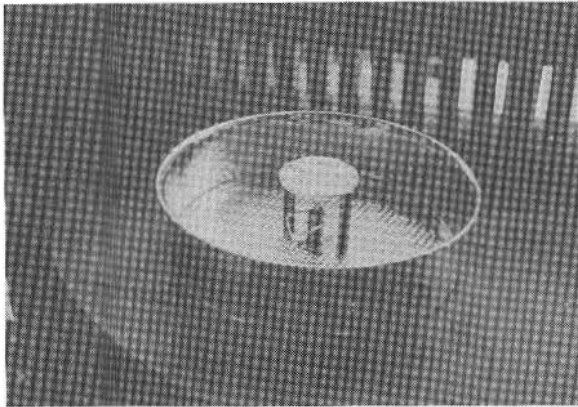

Fig.5:
Prototype of 13cm
'Cakefire' Antenna

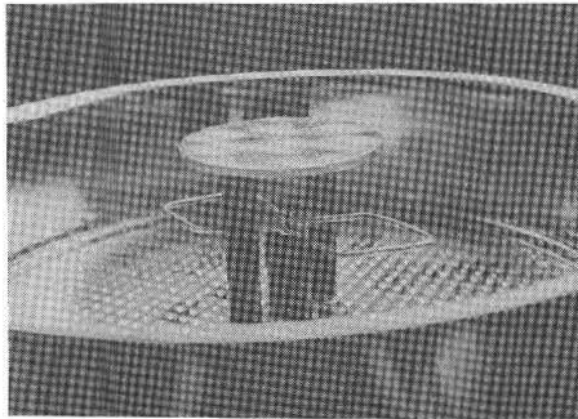
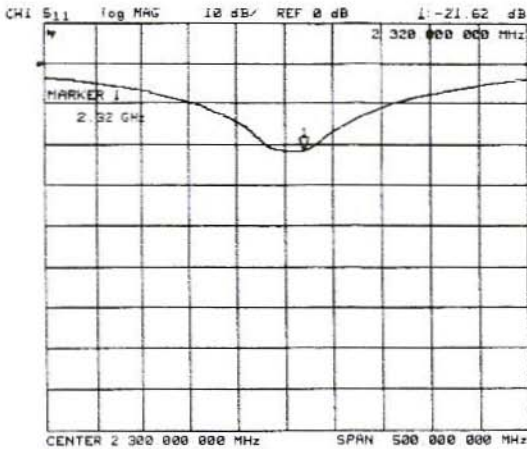

Fig.6:
Detailed Photo showing
Hybrid Quad Transmitter



Graph:
Short Backfire
Antenna for 13cm.
Band as per DL8ZX

big store, I came across a “sprung cake tin”, the dimensions of which I liked, for this had a diameter of exactly 2λ and a collar height of $\lambda/2$, which is what is required for a short-backfire antenna. It didn't even cost me DM10.00 to have this component immediately erected and converted to function as a VHF antenna (Fig.5). When I displayed this antenna at a club meeting one evening, it was immediately baptised the “cake-fire antenna” by a member who liked a “joke”. Unfortunately, I have yet to find any suitable cake tin or pizza pan with the dimensions (37.5cm diameter) of a meteorological satellite antenna.

As the radiator used is symmetrical and the antenna “squints” without the need for any special measures, I used an $\lambda/4$ circuit, open on one side, for matching to an unbalanced coaxial jack. Lean styling can be used to tune the eight-element radiator to 50Ω . Ehrenspeck gives a gain of 13.1dB [1] or 18dB [7] for this antenna, with a normal dipole as radiator, but unfortunately with no source in either case! In comparison

measurements using an industrially produced 25-element Yagi, with a specification of 16.8dB, the short-backfire's results were 5dB lower, i.e. to obtain the same gain, four such short-backfire antennas have to be wired up in the same circuit, or else housed in quite a big joint resonator body. I also included two other known types of antenna in the comparison measurements. In comparison with the 25-element antenna referred to, the well-known “Münchner Gruppe” equipment scored 10.5dB and the DL7KM radiator 6dB. The literature referred to also mentions additional directors in front of the $\lambda/4$ resonator

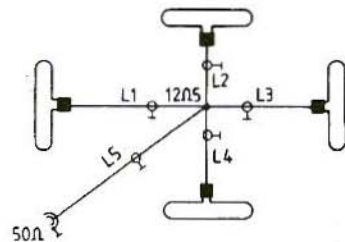

Fig.7: Matching individual Radiators for 23cm.
L1 to L4 = 50Ω
L5 = 25Ω

disc, but I have not tried this yet. So this antenna gave a similar gain to that for a "Yagi" with about 15-elements. Special-steel cake tins are also on the market, for constructions with a higher mechanical stability.

3. OMNIDIRECTIONAL ANTENNAS

There follows a description of omnidirectional antennas for 70, 23 and 13cm, as I constructed them as indoor beacon

antennas for the DFOANN beacon.

3.1. 70cm Antenna

The first omnidirectional antenna assembled and tested was a Maltese cross antenna [8]. Of course, the omnidirectional characteristic was unsatisfactory. I then started to build a big wheel, the technical specifications for which can also be found in [8]. The biggest difficulty in making this myself turned out to be the mechanical construction. A detailed description can be found in [10] VHF Communications 2, 1995.

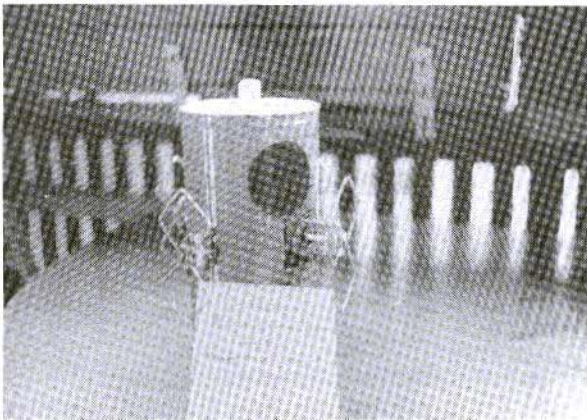

Fig.8:
Prototype of 13cm.
Omnidirectional Antenna

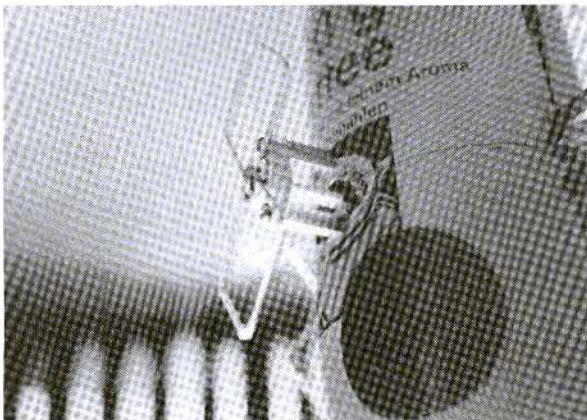

Fig.9:
Detailed Photo of an
8-Element Radiator

3.2. 23cm Antenna

Experiments were carried out with a big wheel for the 23cm band as well, but because of the poor reproducibility another path was selected. As the patterns were already very manageable at this high frequency, the radiator was constructed as a printed circuit board. I used an aluminium plate at a distance of $1/4\lambda$ as a reflector. The radiator was fastened to the reflector with four distance bolts.

Two pieces of sheet metal, bent into the shape of a U or screwed together in the form of a lantern, were used for the omnidirectional antenna. For this antenna design, a case wave barrier was also provided, which can be constructed using a $\lambda/4$ stub. To obtain omnidirectional radiation, whichever antenna is opposite must be powered through a 180° angle [8].

Tuning to 50Ω is done through transformation circuits housed within the structure. An N-socket is mounted on the front face of the lantern structure. At these high frequencies, open chassis built-in jacks should be replaced by cable built-in jacks to avoid reactive components.

Before group antennas are hooked up, it is advisable to tune all individual radiators to 50Ω first, for good matching.

For double-hybrid radiators, tuning can be accomplished by altering the distance from the reflector, by lean styling the eight-element radiator (wire format), or by L/C wiring at the connection point.

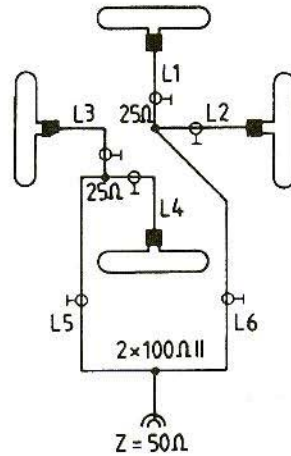

Fig.10: Hook-Up of individual Radiators
 Wires 1 to 6 = 50Ω
 L5, L6 = 0.75λ
 L1 to L4 the same length

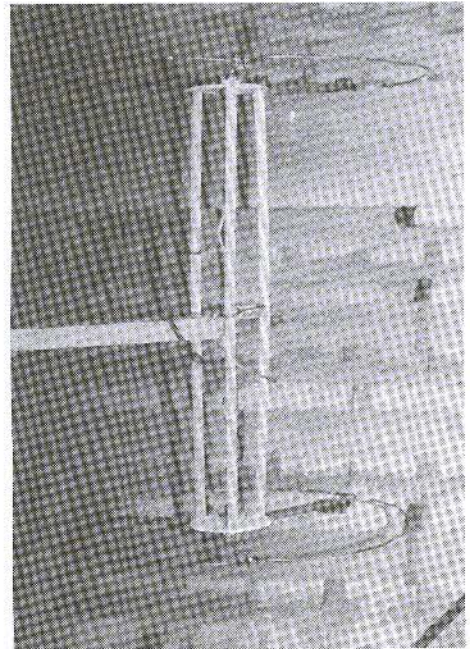
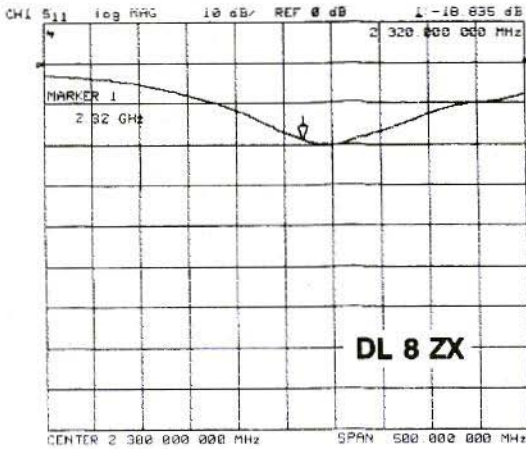

Fig.11: Stacked Big Wheel under Roof



Graph:
 Hybrid Quad
 Omnidirectional
 Antenna for 13cm
 Band as per DL8ZX

3.3. 13cm Antenna

Once the hybrid quad radiator form had proved itself in the 23cm band, a similar structure was assembled for the 13cm band. While I was cogitating about the antenna carrier, I made myself a coffee. This drew my attention to the coffee tin, which would certainly be a more suitable antenna carrier (reflector) than the "lantern format". After dividing up the "antenna carrier" into four segments, I attached the radiator, made from Cu-Ag wire, to ceramic holders, at a distance of $\lambda/4$, and attached them to the coffee tin with distance bolts. As already mentioned in publication [9], the transmitter dimensions can be scaled to correspond to the frequency ratio. I then measured and calibrated the individual antennas. With the structure I was using, I had to wire a 3.3pF capacitor up in parallel (standard value), with lengths of wire each 1.5cm long at the connection point. A trimmer can also be used for calibration here, and you can use NWA for measurements, if available. The high-frequency connection I selected was an N-type built-in cable jack with

single-hole fixing, which was mounted in the tin's base. The individual antennas were inter-connected through precisely dimensioned transformation circuits, and then the voltage standing

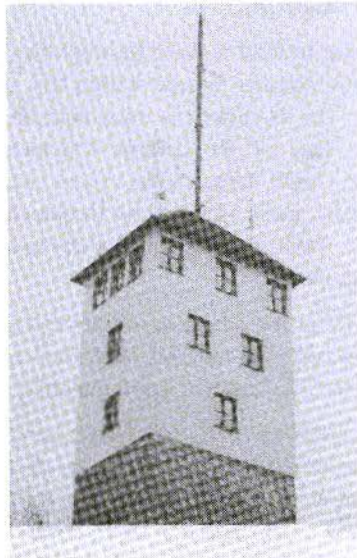

Fig.12: Antennas of Repeater and Beacon Location JN59PL



wave ratio was checked. So-called "Philips winding trimmers" (as used in radio in the post-war era) can be used to calibrate at the best SWR at the connection points of the matching stubs, which may be bared only for very short periods. With standard trimmers, you can't normally obtain C-values < 1pF. The assembly is carried out as follows. A piece of CuAg wire app. 5 to 10mm long is soldered onto the "hot potential". A few turns of enamelled or plastic-insulated thin wire are then wound around these supports to act as the stator of the capacitor. The taped external conductor is earthed at one end. The loose end can now be coiled on and off, using a pair of tweezers or a little plastic rod (do not attach with wax or the like, as this changes the dielectric). As only very low capacitance values are required with UHF, the inductance created by coiling on has no great part to play.

4.

LITERATURE

- | | |
|---------------------------------------------------------------------------------------------------------------|-----------------------------------------------------------------------------------------------------------------------------------------------------------------------------------------------------------------------------------------------------------------------------------------------------------------------------------------------------------------------------------------------------------------------------------------------------------------------------------------------------------------------------------------------------------------------------------------------------------------------------------------------------------------------------------------------------------------------------------------------------------------------------------------------------------------------------------------------------------------------------------------------------------------------------------------|
| <p>[1] Hermann W.Ehrenspeck
Short-Backfire Antennas as UHF
Antennas
Funktechnik, no. 16, 1971</p> | <p>[2] Hermann W.Ehrenspeck
Backfire Antennas
NTZ, no. 5, 1969</p> <p>[3] A.C.Lange
Short-Backfire Antennas with
Waveguide and Linear Fields
Microwave Journal, no. 8, 1976</p> <p>[4] Dr. Akhileshar Kumar
Modified Backfire Lowers
Cross-Polarisation Levels
Microwaves, no. 6, 1977</p> <p>[5] Alan G.Martin
Short Backfire Antenna for
Doppler Sensing
Microwave Journal, no. 10, 1981</p> <p>[6] P.Federspieler and Hans H.Meinke
Vortex Zones of Electrical Energy
with Backfire Antennas
NTZ, no. 1, 1974</p> <p>[7] Hermann W.Ehrenspeck and John
A.Strom
Short-Backfire-Antenna a Highly
Efficient Array Element
Microwave Journal, no. 5, 1977</p> <p>[8] Rothammel
Antenna Book</p> <p>[9] K.Weiner, DJ9HO
UHF Base</p> <p>[10] E.Berberich
Big Wheel Antenna for the 70cm.
Band
VHF Communications 2, 1995, pp.
123-126</p> |
|---------------------------------------------------------------------------------------------------------------|-----------------------------------------------------------------------------------------------------------------------------------------------------------------------------------------------------------------------------------------------------------------------------------------------------------------------------------------------------------------------------------------------------------------------------------------------------------------------------------------------------------------------------------------------------------------------------------------------------------------------------------------------------------------------------------------------------------------------------------------------------------------------------------------------------------------------------------------------------------------------------------------------------------------------------------------|



Steen Gruby, OZ9ZI

Reliability of Gain Specifications for Antennas

A few years ago, I bought myself a commercially manufactured amateur radio antenna made by a Japanese firm, which was designed for the frequency range between 1240 and 1300 MHz. My experiences with this antenna and the reliability of the technical data listed for the antenna formed the basis for this article.

1. INTRODUCTION

Previous experience of antenna measurement - in Haslev in 1985, etc. - had already given me some idea of what should be expected when the gain specifications for an antenna are investigated in reality using a test rig.

There are many methods of measurement which refer back to the logarithmic Bell scale. The dBi unit stands, for

example, for a gain measured with an isotropic source antenna as reference antenna. The dBd unit, by contrast, stands for the gain which is measured against a dipole as reference antenna.

The isotropic source antenna is a hypothetical isotropic source, which technically can not be manufactured, and so the specialist uses the dBd unit of measurement as the most honest unit. The metrological difference between an isotropic source and a dipole amounts to 2.16dB in favour of the dipole, so 2.16dB units must be added to any gain specification in dBi units.

dBa is a unit of measurement which is used for acoustic measurements - i.e. sound measurements. The term "dBa" could also be used to stand for "dB (radio) amateurs", but that would be a very confused value. I could imagine introducing the units of measurement dBg, in German, and dBt / dBb, in Danish / English, with the following meanings:



dBg for “glauben” (“believe”),
dBt for “tro”, and
dBb for “believe”.

These descriptions would stand for what radio amateurs actually do when they uncritically accept the data for a commercially manufactured antenna. And how can you know what reference value was used to “measure” the antenna in question (assuming there was a measurement in the first place)?

2. THE MYTH

We radio amateurs are therefore compelled to place our trust in the technical data from the manufacturer, because we have no simple way of checking them. Hence the new term dBg, because most things involving antennas and antenna gain specifications are a matter of belief or trust.

Manufacturers of antennas for professionals are also compelled to adhere to the limits specified for their products, since many of their customers are in a position to check them. It can therefore be assumed that the data provided by such firms correspond to the facts and that, as a rule, the antennas are also supplied with a radiation pattern obtained using metrology.

Things are different for those manufacturers whose products are almost exclusively sold on the amateur radio market. Here we are given fantasy values as “free extras”. To put it another way, there is no comparison between the

antennas which are supplied to the professional market and those which people want to palm off onto us radio amateurs.

If suppliers of antennas for radio amateurs are actually in a position to measure the values shown in their advertisements, why then don't professional users buy antennas from them, instead of paying higher prices for apparently worse products? The explanation for this is that the actual technical data for antennas for radio amateurs do not correspond to the data in the adverts. When I say that, this does NOT mean that all antennas which are available on the amateur radio market are useless. I merely wish to point out that a healthy scepticism should be exercised here in relation to the values specified.

3. THE FACTS (or those available)

There are antennas for radio amateurs, the actual performance of which does correspond to the specified data. However, these have a hard time competing with those for which the data are expressed in dBg units - the gain is just the most important characteristic laid down.

Another disadvantage with antennas for radio amateurs is that a radiation pattern is not normally provided. It is thus not possible to obtain an impression of whether the desired gain is actually where you need it. It is in fact very

difficult to construct collinear antennas in such a way that the radiation pattern gives a maximum value in the horizontal plane - and the higher the desired gain, the more difficult it becomes.

To put it another way, if a wire which is several wavelengths long has power fed into it at one end, the radiation is directed to the other end of the wire. So a wrongly adjusted collinear antenna usually gives a radiation characteristic which is directed upwards, i.e. from the end of the antenna. But at the point where the gain should be located some attenuation is taking place, i.e. a negative gain, by comparison with a dipole.

This is precisely what I found was happening with the antenna which I had bought for the frequency range between 1240 and 1300 MHz. This was a Maldol antenna, type HS-GP 1219, which was tested against other antennas in a measuring field.

I then wanted to carry out specific measurements on antennas manufactured for radio amateurs. I leave it to you, dear reader, to determine how useful these antennas are.

4. ANTENNA MEASUREMENTS

In my opinion, the antennas selected for these measurements are those most frequently purchased. They are certainly those most frequently mentioned in our region. Here is a list of the models (from various manufacturers):

COMET	CA-2x4 MAX, 2 bands, 144 & 432 MHz, length 5.40m
COMET	CA-2x4 Super II, 2 bands, 144 & 432 MHz, length 2.43m
COMET	CX-902, 3 bands, 144, 432 & 1296 MHz, length 3.07m
COMET	CA-1221S, 1 band, 1296 MHz, length 2.34m
DIAMOND	X-6000 W, 3 bands, 144, 432 & 1296 MHz, length 3.05m
DIAMOND	X-300, 2 bands, 144 & 432 MHz, length 2.09m
MALDOL	HS-GP 1219, 1 band, 1200 MHz, length 1.99m

4.1. Measuring Field

The measuring field in which the measurements were carried out belongs to Danish Telecom, and is a licensed measurement field which is regularly inspected. The measurements were carried out by Danish Telecom employees, who are completely familiar with the use of the measuring field and the associated measuring systems. Thus any doubts about the serious nature of the measurements below can be excluded in advance.

Measurements were carried out for all the antennas at the frequencies referred to in the frequency plan for IARU Region 1: in the 2m. band at 144, 145 and 146 MHz, in the 70cm. band at 432, 434, 436 and 438 MHz, and in the 23cm. band at 1296, 1297 and 1298 MHz, where predominantly vertically polarised communications traffic takes place.

The performance of the Maldol antenna was also measured over an extensive

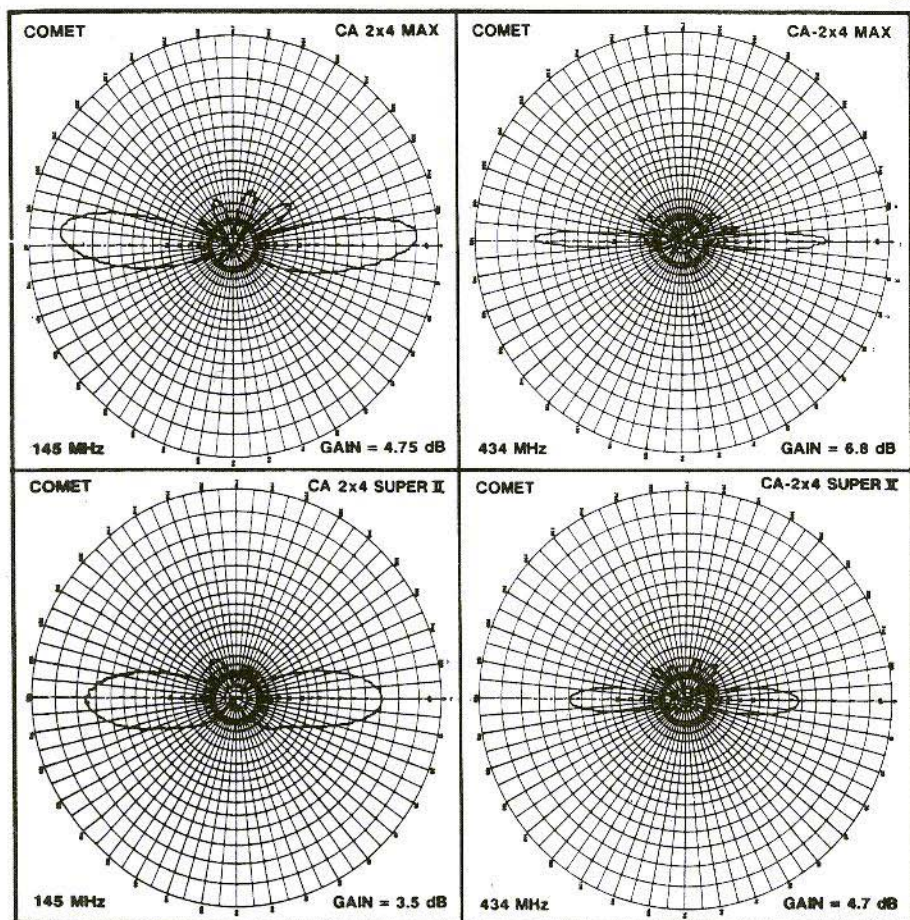

Fig.1: Horizontal Radiation Patterns: CA 2x4 MAX & CA 2x4 SUPER II

band width up to 1195 MHz, in an attempt to find an explanation for its radiation characteristic. This was repeated with the Comet CA-1221 S, as this is also a single-band antenna for 1296 MHz, which is supposed to cover the entire band width.

The antenna gain was measured vertically to the antenna or in the horizontal plane. This kind of measurement gives a worse result for antennas for which the main radiation is not situated in the horizontal plane. To summarise the

measurements, an average antenna gain was calculated for the band in question, which applied to the entire band width, as the manufacturers do not state where the specified gain was measured. This value was deducted from the antenna gain specified by the manufacturer, which gave the difference between the values shown in the advertisements and the actual performance of the antennas. In relation to the radiation characteristic, it should be pointed out that "the bottom" (the distributing point of the

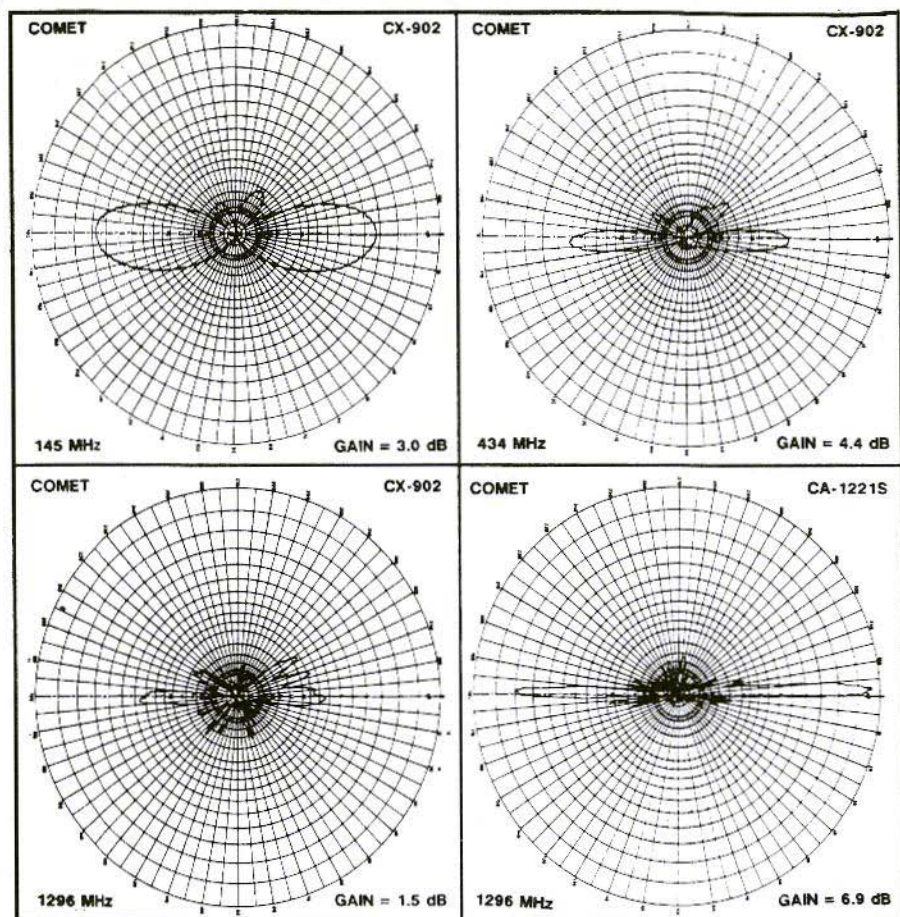

Fig.2: The 1296 MHz diffuse directional response pattern for the CX-902 and the level radiation pattern for the CA-1221 S are easily recognisable

antennas) is at the 90-degree point for all measurements. That means that an upward radiation due to structural errors, which is characteristic of some antennas, is a radiation in the direction of the 270-degree point.

4.2. Test Results

The Maldol antenna registered an upward radiation amounting to 10 to 20 degrees, which varied over the band

width, at all frequencies in the range between 1240 and 1298 MHz. For antennas with a high gain, the beam angle was so small that there was a dead zone in which no signal was available. As regards the Maldol antenna, there was a very specific attenuation effect here - more than 10dB, as against a dipole. The antenna gain was specified as 12.2dBi. The antenna was thus one of two antennas measured, the gain of which was specified with reference to

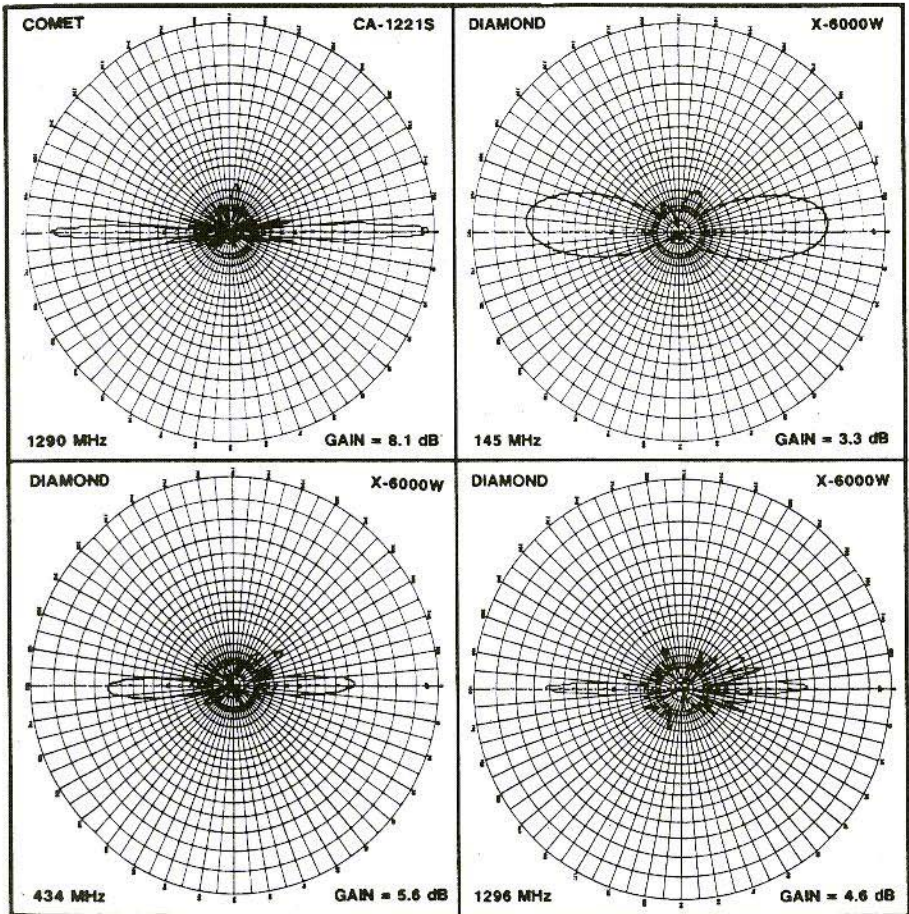

Fig.3: The Diamond X-6000 does not carry conviction at 23cm either

an isotropic source. So that it could be compared with the other antennas, then, 2.16dB had to be deducted, which still left a gain of 10.04dBd. Naturally, at 1,296 MHz the antenna displayed a gain of approximately 6.5dBd, though of course at an angle which was no fun for anyone, since the signal was radiated heavenwards. (See also Fig.4, bottom right). A measurement at 1195 MHz gave a gain of 9.9dBd and a radiation characteristic in the correct position. If

the antennas had been intended for use at 1,200 MHz, they would have had precisely the right technical data.

Specified values for the Comet CA-2x4 Max twin-band non-directional antenna were 8.5dBd, for 144 MHz - and 11.5dBd, for 432 MHz. The radiation pattern (Fig.1) showed an upward radiation of 7 to 8 degrees at 144 MHz, rising to 12 - 13 degrees at 146 MHz. As can be seen from the table, the gain measured varied somewhat over the

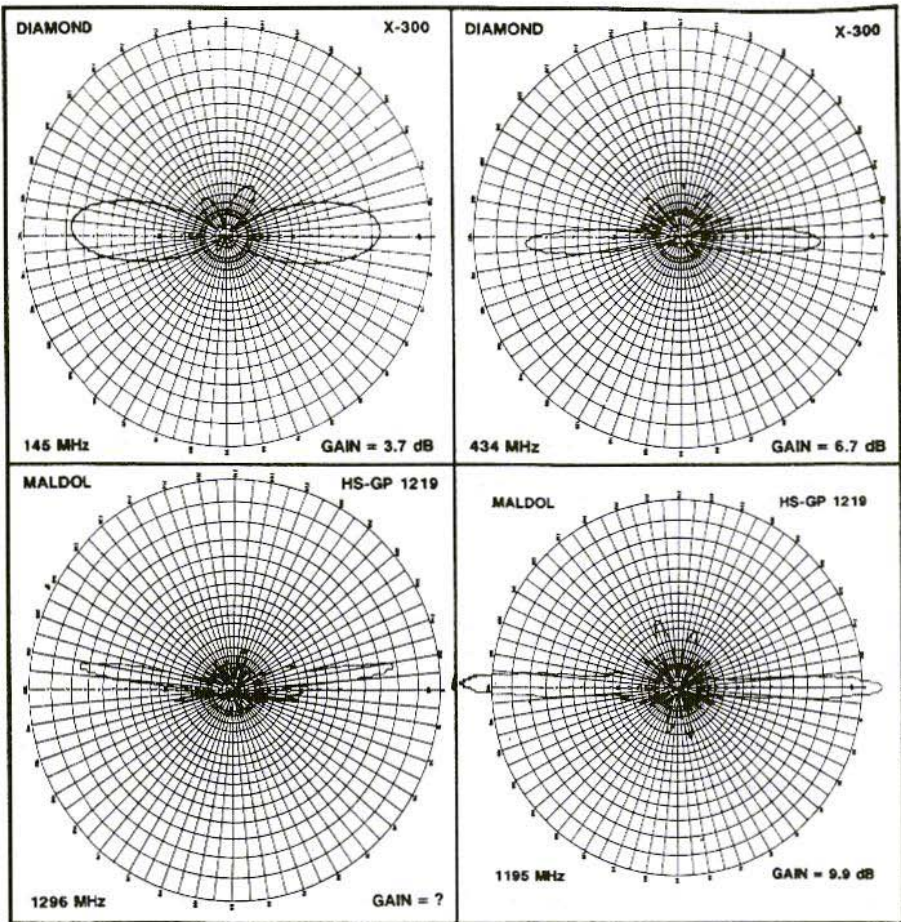

Fig.4: The relatively good radiation pattern for the Diamond X-300. The Maldol HS-GP 1219 is clearly resonant outside the 23cm band limits.

entire band width. The average gain was 4.3dBd, i.e. 4.2dB below the manufacturer's specifications. At 70cm, the radiation characteristic was acceptable over the entire band width.

The gain between 432 and 436 MHz was 6.5dBd. At 438 MHz, the gain fell back to 5dBd. The average gain amounted to 6.25dBd, i.e. 5.15dB below the manufacturer's specifications.

The specified values for the Comet CA-2x4 Super II were 6.0dBd at 144 MHz and 8.4dBd at 432 MHz. The radiation patterns for both bands were acceptable, with a negligible downward radiation at 432 MHz (Fig.1). The measured gain varied between 3.6 dBd at 144 MHz and 2.3dBd at 146 MHz. The average gain was 3.1dBd, i.e. 2.9dBd too low. As can be seen from the table, the gain measured at 70cm oscillated between 4.7dBd and 3.2dBd



over the entire band width. There was an average gain of 4.2dBd, i.e. exactly half the value specified by the manufacturer.

The values registered for the Comet CX-902 should be 6.5dBd at 144 MHz, 9.0dBd at 432 MHz and 9.0dBd at 1296 MHz. The radiation characteristic looked good at 2m. Radiation directed a few degrees downwards at 70cm could be detected. This was also acceptable. At 23cm, the radiation characteristic looked very bad. It could be described as diffuse (Fig.2). The measured gain at 2m was 3.0dBd at 145 MHz. At 144 MHz and 146 MHz, it was 1.4dBd. The average gain was 1.9dBd, i.e. 4.6dB below the specified value. The measured gain at 70 cm. amounted to 4.2dBd at 432 MHz, 4.4dBd at 434 MHz, 3.9dBd at 436 MHz, and to only 2.1dBd at 438 MHz. There was an average gain of 3.65dBd, i.e. 5.35dB too low. Due to the poor radiation pattern, the measured gain at 23cm was 1.5dBd at 1296 MHz, and down to only 0.9dBd at 1298 MHz. The average gain was 1.23dBd, i.e. 7.7 dB less than the value promised by the manufacturer!

The Comet CA-1221S should have a gain of 14.8 dBi at 1,296 MHz. Since the gain for this antenna is specified in dBi, just as for the Maldol antenna, once again we have to deduct 2.16dB, leaving 12.6dBd. Since this is a single-band antenna, measurements were carried out over a larger band width. At 1298 MHz, there was an upward radiation of a few degrees (Fig.2), at 1290 MHz the radiation direction was satisfactory, and at 1260 MHz there was a slight downward radiation. The maxi-

imum antenna gain was 8.1dBd at 1290 MHz. It fell to 6.7dBd at 1298 MHz and 5.8dBd at 1298 MHz. The gain over the entire band width was 7.1dBd, i.e. 5.5dB below the value specified by the manufacturer -5.9dB below in the upper range.

The Diamond X-60000W should display a gain of 6.5dBd at 2 m, 9.0dBd at 70cm, and 10dBd at 23cm. At 2m, the radiation characteristic displayed a slight upward radiation of between 3 and 4 degrees. At 70cm, it was good for the range between 434 and 436 MHz, and had rather a lot of large side lobes at 432 and 438 MHz. The radiation pattern for 1296 MHz was a study in side lobes (Fig.3), in which the gain which the antennas are specified as having had apparently disappeared. The major lobe was about where it should have been, but the biggest side lobes were 4dB, 5dB or 6dB lower. The gain measurement gave 3.6dBd at 144 MHz, 3.3dBd at 145 MHz and 2.0dBd at 146 MHz. The average value was 3.0dBd, i.e. 3.5dB too low. Values for the 70cm band were 5.0dBd at 432 MHz, 5.6dBd at 434 MHz, 5.2dBd at 436 MHz and 4.1dBd at 438 MHz. The average value was 5.0dBd, i.e. 4.0dB lower than specified in the data sheet. The 23cm. band gave results as follows: 4.6dBd at 1296 MHz, 4.1dBd at 1297 MHz and 4.5dBd at 1298 MHz. The average value registered was 4.4dBd, i.e. 5.6dB too low.

The Diamond X-300 should display 6.5dBd at 2m, and should have a gain of 9.0dBd at 432 MHz. A weak upward radiation was detected in the 2m band, with a weak downward radiation in the

GAIN MEASUREMENTS ON OMNIDIRECTIONAL AMATEUR RADIO ANTENNAS		MEASURED GAIN [dBd]					
		2m-Band	70 cm-Band		23 cm-Band		
MANUFACTURER	TYPE NO.	MANUFACTURERS' STATED GAIN	ANTENNA HEIGHT (TOTAL)	CALIBRATION FREQ: 145 MHz REF. ANT. TYPE: ANRITSU MP-554B SOURCE ANTENNA: LOG PERIODIC	CALIBRATION FREQ: 438 MHz REF. ANT. TYPE: ANRITSU MP-554C SOURCE ANTENNA: 0.08-1.95 CHS LOG PERIODIC	CALIBRATION FREQ: 1297 MHz REF. ANT. TYPE: ANRITSU MP-561B SOURCE ANTENNA: LOG PERIODIC	
				TEST PATH LENGTH IN METERS: 33 m IN LAMBDA: ~ 16 λ	TEST PATH LENGTH IN METERS: 33 m IN LAMBDA: ~ 40 λ	TEST PATH LENGTH IN METERS: 33 m IN LAMBDA: ~ 142 λ	
COMET	CA-2x4 MAX	144 MHz: 8.5dB	5.40m	144MHz 146MHz 4S2MHz 438MHz 438MHz	4.7 4.75 3.5 6.7 6.8 6.5 5.0	— — —	
		430 MHz: 11.9dB		Average = 4.3 Overall: 8.5-4.3 = 4.2	Average = 6.25 Overall: 11.5-6.25 = 5.25	— — —	
		144 MHz: 6.0dB 430 MHz: 8.4dB		Average = 3.1 Overall: 6.0-3.1 = 2.9	Average = 4.2 Overall: 8.4-4.2 = 4.2	— — —	
COMET	CX-902	144 MHz: 6.5dB	3.07m	144MHz 146MHz 4S2MHz 438MHz 438MHz	1.4 3.0 1.4 4.2 4.4 3.9 2.1	1.5 1.3 0.9	
		430 MHz: 9.0dB 1200 MHz: 9.0dB		Average = 1.9 Overall: 6.5-1.9 = 4.6	Average = 3.65 Overall: 9.0-3.65 = 5.35	Average = 1.23 Overall: 9.0-1.23 = 7.77	
		1260- 1300 MHz: 14.8 dBi		Average = 3.1 Overall: 6.0-3.1 = 2.9	Average = 4.2 Overall: 8.4-4.2 = 4.2	6.9 6.5 6.7 Average = 6.7 Overall: 12.7-6.7 = 6.0	
DIAMOND	X-6000W	144 MHz: 6.5dB	3.05m	144MHz 146MHz 4S2MHz 438MHz 438MHz	3.6 3.3 2.0 5.0 5.6 5.2 4.1	4.6 4.1 4.5	
		430 MHz: 9.0dB 1200 MHz: 10.0dB		Average = 3.0 Overall: 6.5-3.0 = 3.5	Average = 5.0 Overall: 9.0-5.0 = 4.0	Average = 4.4 Overall: 10.0-4.4 = 5.6	
		144 MHz: 6.5dB 430 MHz: 9.0dB		Average = 3.4 Overall: 6.5-3.4 = 3.1	Average = 6.25 Overall: 9.0-6.25 = 2.75	— — —	
MALDOL	HS-GP 1219	1260- 1300 MHz: 12.2 dBi	1.99m	144MHz 146MHz 4S2MHz 438MHz 438MHz	— — —	— — —	
		— — —		— — —	— — —	Read text and see radiation pattern	

Table 1: Summary listing of Antennas tested, with Manufacturers' Gain Specifications and Measured Values



70cm. range, but both were insignificant (Fig.4). The measured gain in the 144MHz band looked like this: 4.1dBd at 144 MHz, 3.7dBd at 145 MHz, and 2.5dBd at 146 MHz, giving an average value of 3.4dBd, which was thus 3.1dB below the promised gain. The picture in the 432MHz band was: 6.6dB at 432 MHz, 6.7dBd at 434 MHz, 6.4dBd at 436 MHz, and 5.3dBd at 438 MHz, giving an average value of 6.25dBd, which was "only" 2.75dB from the value the manufacturer wishes to talk us into accepting. Of the antennas tested here, the values measured for these antennas were, coincidentally, closest to the specified values.

Well, 2.75dB isn't such a large deviation - or is it? Well unfortunately, antenna gain specifications involve a logarithmic unit of measurement. So an alteration of 3dB means the value is halved or doubled. So the antennas for which the specifications were checked were not even half as good as the manufacturers made them out to be. If you bought a car with a specified maximum speed of 200 km/h, and then you found out the maximum speed was 100km/h, you'd certainly complain about it immediately! What we're talking about here is of the same order of magnitude!

4.3. Summary of Test Results

The average values for the Comet are 3.9dB lower than the specified values for the antenna in the 2m band, 3.9dB lower in the 70cm band, and as much as 6.9dB lower in the 23cm band. The Diamond values registered are 3.0dB lower than the specifications for

144 MHz, 3.4dB lower for 432 MHz, and 5.6dB lower for 1296 MHz. See also summary in Table 1!

If we summarise the values specified by the two manufacturers, we obtain the following average deviations:

3.45dB at 144 MHz

4.15dB at 432 MHz

6.25dB at 1296 MHz

Earlier in this article, I introduced the terms dBg, dBt and dBd. I might now also consider introducing the unit dBj, where j stands for Japan. In accordance with this, the dBj values (as per the above table) would have to be copied from the specifications for Japanese antennas, to obtain a value which MAY be correct.

5. CONCLUSION

I am well aware that this article may trigger intense discussion, but the figures speak for themselves.

In writing this article, I have tried to ensure that my fellow radio amateurs adopt a critical attitude to specifications and insist on receiving reliable information from manufacturers. At the same time, I was also calling on the manufacturers to provide data based on actual documented measurements regarding their products.



Richard A. Formato, Ph.D., K1POO

Improved Impedance Loading for Wideband Antennas

1. . INTRODUCTION

Antennas and resistors are usually like oil and water - they don't mix, at least most of the time. The classic example of an absolutely terrible antenna with an excellent SWR is a dummy load. A good dummy load's response is nearly flat well into the UHF range. But because essentially all input power is dissipated as heat from i^2R (Joule heating) losses, its radiation efficiency is for practical purposes zero.

Adding resistance to an antenna invariably reduces efficiency, and, as a general rule, adding more resistance makes the antenna worse. But resistance isn't always bad. As the dummy load shows, resistance can broaden an antenna's response by flattening the variation of input impedance with frequency. Certain types of communication systems benefit substantially from wideband an-

tennas, typical examples being spread spectrum, frequency-agile, and ALE (automatic link establishment) systems. In each case it is desirable to maximize antenna bandwidth while maintaining acceptable power gain and radiation pattern. One way to accomplish this objective is to add resistance.

The question is how much resistance should be added to strike a reasonable balance between wider frequency response and reduced radiation efficiency. Adding the correct amount of resistance at the proper location can significantly extend an antenna's frequency range while still providing quite acceptable efficiency and gain. This article describes an improved technique for computing the required loading profile for simple wire antenna elements. A typical monopole antenna is then discussed that provides continuous coverage from about 12 MHz to beyond 150 MHz with no tuner or matching network.



2. BACKGROUND

The idea of adding resistors to an antenna to improve frequency response has been around for a long time. In 1953 Willoughby [1] discussed resistively-loaded wires in a variety of configurations, including Vees and Rhombics, that provided wideband transmit and receive antennas. The wires were loaded either with discrete resistors or with a gradually tapered resistance profile such that the end nearest the RF source had the lowest resistivity and the end farthest from the source had the highest.

Resistance can transform a resonant, standing-wave antenna element into a non-resonant, travelling-wave element, thereby increasing the loaded antenna's bandwidth. The distinction between resonant (standing-wave) and non-resonant (travelling-wave) antenna elements can be illustrated by considering the Centre-Fed Dipole (CFD) antenna in

Figure 1. In the unloaded antenna, resonance results from the superposition of outward-travelling waves produced by the RF source and reflected waves generated at the impedance discontinuity at the CFD's free ends.

These two oppositely propagating waves combine to produce a standing wave which determines the CFD's resonant frequency. If, however, the outward-travelling wave were not reflected, then no standing wave would exist, and the CFD would not exhibit resonance. One way to minimise reflections is to add resistance near the ends of the element. The resistors absorb incident energy that has not been radiated away from the antenna, thereby reducing the reflected wave amplitude. This general principle underlies all resistive loading schemes. Of course, there are many ways in which resistance can be added to an antenna, and different approaches can produce dramatically different results.

Altshuler [2] provided the first analysis of the effect of adding a discrete resistance to the CFD. He found that an

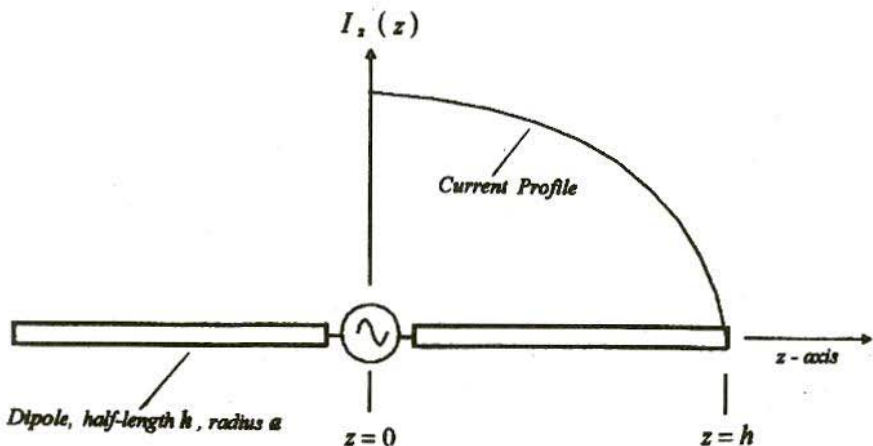

Fig.1: The Centre-Fed Dipole

essentially travelling wave current distribution resulted from inserting a 240Ω resistor in each arm of the dipole a distance $\lambda/4$ from the end. The radiation efficiency was reduced by about 50%, but the input impedance was essentially constant over a 2:1 frequency range. Altshuler's work provided impetus for Wu and Kings [3] landmark paper on continuously loaded antennas. Their work forms the basis of recent efforts to improve bandwidth by adding resistance. It is discussed in more detail below.

Some of the results achieved with loaded antennas have been quite impressive. Kanda [4] built a very small receive-only field probe (a loaded CFD) that exhibited essentially flat frequency response from HF to beyond 1 GHz. This sensor was so heavily loaded, however, that its radiation efficiency was far too low for it to be useful as a transmit antenna. Rama Rao and De-broux [5, 6] described a 35-foot loaded HF monopole with $SWR \leq 2$ from 5-30 MHz and radiation efficiency ranging from about 15%-36%. This antenna used a fractional loading profile equal to 0.3 times the Wu-King profile and a fixed, lumped-element matching network. Other loading profiles have been proposed that combine resistance and inductance to improve bandwidth and efficiency [7].

This article describes a modification of the original Wu-King (WK) profile that increases antenna bandwidth by creating a travelling-wave element while at the same time improving radiation efficiency by increasing the antennas average current. Because the radiated fields

are proportional to the antennas $I dl$ product, a higher average current increases the radiated fields, which in turn improves efficiency. The motivation for this new profile is the realisation that the WK current profile is a special case of a more general travelling-wave current distribution with higher average antenna current.

3.

WU-KING THEORY

Figure 1 shows a CFD antenna consisting of two elements of length h and radius a . The amplitude of the current profile is plotted schematically along one elements length. Maximum current occurs at the RF source at the feed point, and the magnitude decreases along each arm until it reaches zero at the end. In the WK model, the CFD is assumed to have an internal impedance profile along the wire element given by

$$Z^i(z) = R^i(z) + jX^i(z)$$

where Z^i is the (complex) internal impedance per unit length (ohms/meter) consisting of lineal resistance R^i and reactance X^i , and where $j = \sqrt{-1}$.

Wu and King develops the differential equation satisfied by the current $I_z(z)$, and then determines *by inspection* that a travelling-wave current mode exists for one particular impedance profile Z^i . The WK current distribution is:

$$I_z(z) \approx \left(1 - \frac{|z|}{h}\right) \exp(-jk_0|z|) \quad (1)$$

Linear
Traveling Wave Factor
Amplitude Decay



which consists of the product of a linearly decreasing (“straight line”) amplitude and a travelling wave propagation factor in the complex exponential term. $k_o = 2\pi / \lambda$ is the wave-number. The propagation factor represents a current wave progressing outward along each dipole arm. There is no reflected wave propagating toward the source to form a standing wave pattern, and consequently no resonance effect.

This current distribution exists *only* when the CFD element has a specific “1/z” internal impedance profile. The required profile is given by:

$$Z^i(z) = \frac{60(\psi/h)}{1 - \frac{|z|}{h}}, \quad (2)$$

where $\psi = \psi_R + j\psi_I$ is the complex expansion parameter discussed in Altshuler [2] with real and imaginary parts subscripted *R* and *I*, respectively. ψ is the ratio of the antenna elements vector potential to current, and is approximately constant along its length.

Because ψ varies with frequency, it is usually evaluated at the fundamental CFD resonance, that is, when $h=\lambda/4$ (see [3] for details). The 1/z profile in equation (2) is the basis for the resistive loading used in [4], [5] and [6].

4. IMPROVED LOADING PROFILE

An improved loading profile, that is, one that provides better radiation efficiency than the 1/z profile, can be obtained by generalising the WK results. The first step is to assume a *power law* travelling-wave current distribution, of which the WK current distribution is a special case. The next step is to substitute the assumed current distribution into the current equation developed by Wu and King, which then yields the condition that must be satisfied by the elements internal impedance

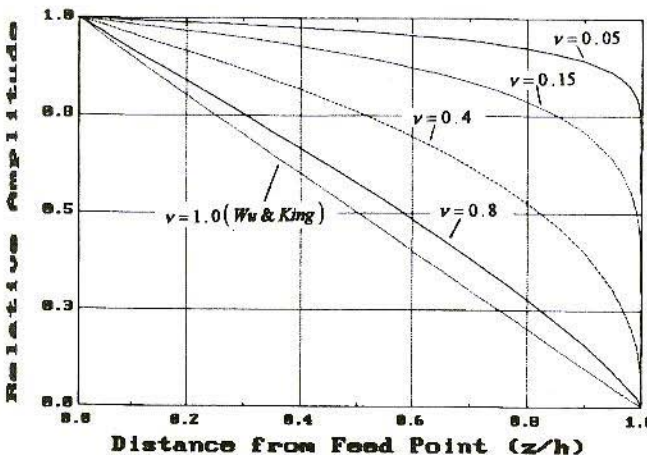

Fig.2: Current Amplitude Distributions

in order to generate travelling-wave only modes. This approach is fundamentally different than the one in WK because the loading profile for a particular travelling-wave current mode is now an unknown which is determined by solving the appropriate equations.

The generalised CFD current distribution is assumed to be of the form:

$$I_z(z) = C(h-|z|)^{\nu} \exp(-jk_0|z|), \quad (3)$$

Power Law
Amplitude Decay Travelling Wave Factor

where C is a complex constant determined by the current at the feed point. Note that the amplitude decay is a power law variation with exponent ν . The Wu and King case is recovered when $\nu = 1$, but when $\nu \neq 1$ the more general case is obtained.

The internal impedance profile that produces travelling-wave only currents of the form in equation (3) is determined as follows. The derivatives dI_z/dz and d^2I_z/dz^2 are computed and substituted into the equation satisfied by $I_z(z)$ [Wu and Kings equation (11)]. This generates the equation that must be satisfied by the auxiliary function $f(z)$ introduced in WK equation (9). Its solution is:

$$f(z) = 2\nu(h-|z|)^{\nu-2} \left\{ 1 - j \frac{\nu-1}{2k_0(h-|z|)} \right\}. \quad (4)$$

$f(z)$ determines the impedance profile. Equation (4) generalises Wu and Kings equation (12), and recovers their results exactly when $\nu = 1$. Figure 2 shows

several current amplitude distributions parametric in the power law exponent ν . It is apparent that values of ν less than 1 can lead to significantly higher average antenna currents. Radiating elements with these current distributions are more efficient than those using the $1/z$ loading profile which results by setting $\nu = 1$.

The loading profile resistance and reactance per unit length are computed from $f(z)$ and are given by:

$$R^i(z) = 60\nu(h-|z|)^{\nu-2} \left\{ \psi_R - \frac{(1-\nu)\psi_I}{2k_0(h-|z|)} \right\} \quad (5a)$$

$$X^i(z) = 60\nu(h-|z|)^{\nu-2} \left\{ \psi_I + \frac{(1-\nu)\psi_R}{2k_0(h-|z|)} \right\} \quad (5b)$$

The corresponding lineal inductance (henry/meter) or capacitance (farad/meter) are given by $L^i = X^i/\omega$ and $C^i = (\omega X^i)^{-1}$, respectively, for $X^i > 0$ and $X^i < 0$. The circular frequency is $\omega = 2\pi f$ where f is the frequency (Hz) at which ω is computed.

It is apparent from equation (5) that the improved loading profile in general contains both resistance and reactance. But adding reactance to the antenna, especially capacitive reactance, can complicate construction.

As a consequence many practical designs employ only resistive loading (see [5] and [6], for example), because excellent results are often achieved even without the loading profiles reactive component.



5. LOADED HF-UHF MONOPOLE

To illustrate the degree of broadbanding that is achievable, a loading profile was computed for a monopole element fed at its base against an infinite, perfectly conducting ground plane. The radiating element height is 5.83 m, and its radius 2.54 cm. The design frequency for evaluating ψ is 12.86 MHz, and the power law exponent ν is 0.05. ψ is $8.961-j2.431$. Using equation (5a), a resistance profile was computed for 14 discrete loading points along the antenna; it is tabulated below. The profile increases very gradually from 0.419 Ω near the base of the monopole to approximately 787 Ω near the top. Reactive loading (in this case inductive) was not included.

Height (m)	Resistance (Ω)	Height (m)	Resistance (Ω)
0.208	0.419	3.123	1.889
0.625	0.489	3.539	2.689
1.041	0.581	3.956	4.129
1.458	0.699	4.373	7.131
1.874	0.859	4.789	15.102
2.290	1.080	5.205	49.473
2.707	1.401	5.622	786.910

The monopoles performance was computer-modelled from 1 to 150 MHz. The computed input SWR for a feed system impedance of 175 Ω appears in Figure 3 (calculated points are marked by X). Because SWR was computed for a 175 Ω characteristic impedance, matching the usual 50 Ω coaxial feed requires a 3.5:1 Unun or another suitable broadband transformer.

The monopole antennas performance is excellent at all frequencies above 36 MHz. The SWR is below 2 from there to 150 MHz (the upper limit for the computer model). It is somewhat worse from approximately 12 to 36 MHz, reaching a maximum of 3.3 at 25 MHz. Below 11 MHz, SWR increases rapidly due to increasing capacitive reactance and decreasing radiation resistance. This behaviour is characteristic of electrically short antennas, and is evident in the monopoles feed point resistance and reactance plots in Figures 4 and 5, respectively. The data in these curves were used to compute the SWR plot in Figure 3.

The monopole antennas impedance bandwidth is remarkably good, especially considering that there is no matching network and only discrete resistive loading is employed. In addition, no attempt was made to further improve the loading profile by, for example, modifying computed resistance values or adding reactance. Adjustments such as these can frequently yield even better performance, but they are not considered further. The following observation illustrates how dramatic the effect of loading an antenna can be. For an *unloaded* monopole, the bandwidth for SWR 2.5 (50 Ω feed) is typically 15-25% of its $\lambda/4$ frequency, depending on the length-to-diameter ratio. A monopole $\lambda/4$ high at 12.86 MHz, such as the one considered here, would exhibit a band-

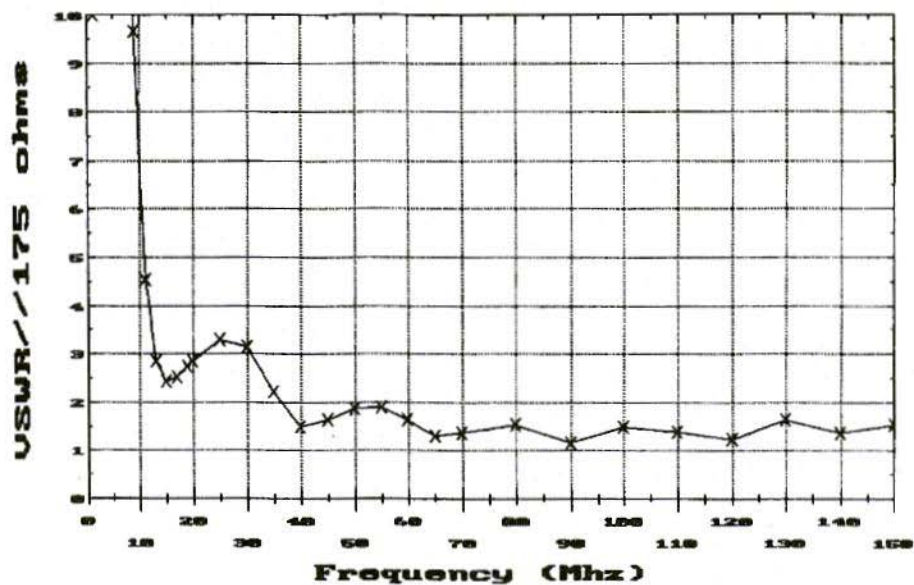

Fig.3: Standing Wave Ratio

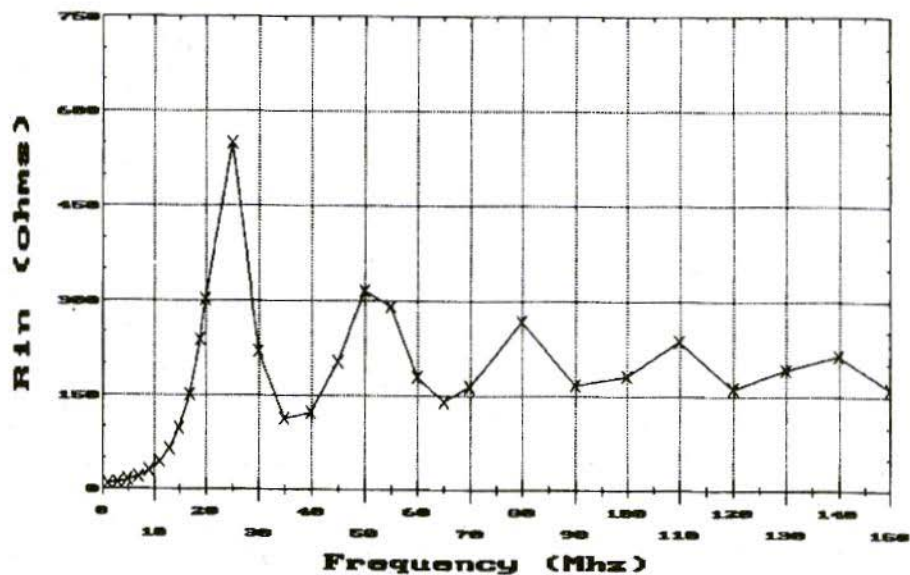

Fig.4: Input Resistance

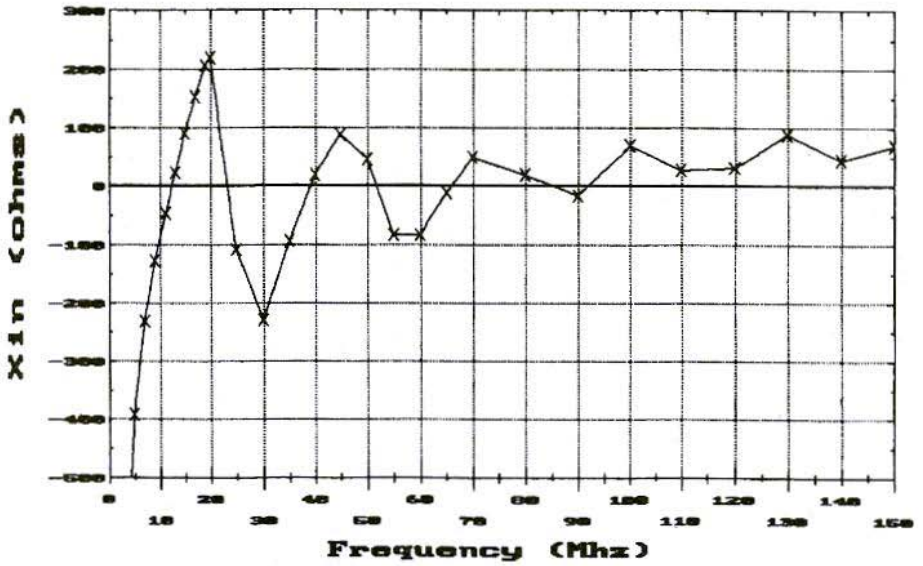

Fig.5: Input Reactance

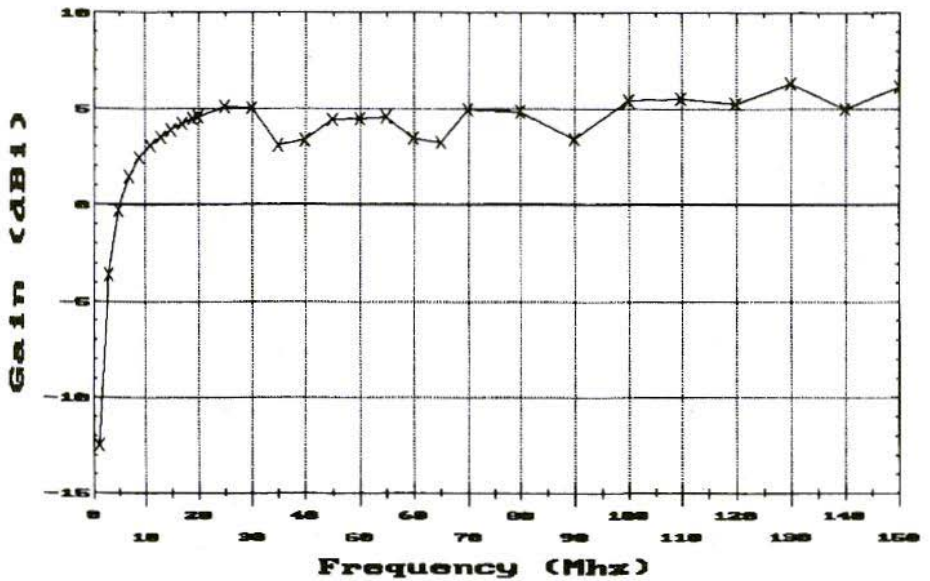

Fig.6: Maximum Power Gain

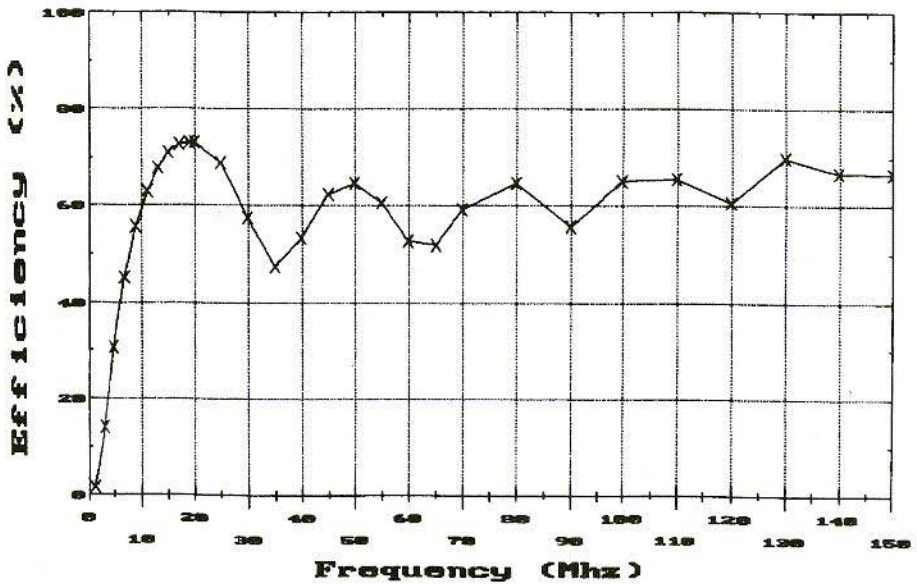

Fig.7: Radiation Efficiency

width of less than 3.2 MHz. Increasing the bandwidth to more than 115 MHz, as the improved loading profile does, is indeed a very substantial improvement.

Of course, as the dummy load example teaches, impedance bandwidth alone does not a good antenna make. Two other key measures of the loaded monopoles performance appear in Figures 6 and 7, maximum gain and radiation efficiency, respectively. The power gain, computed as the product of directive gain and efficiency, is plotted in dBi (decibels relative to an isotropic radiator). For comparison, the maximum power gain of a half-wave CFD in free space is 2.15 dBi. The loaded monopoles gain at 10 MHz is nearly 3 dBi, and from 10 to 150 MHz it is mostly in the 4 to 6 dBi range. The monopole with the improved resistance profile thus exhibits power gain figures that are

typical of similar antennas with no loading at all.

The point was made in the Introduction that the fundamental issue in choosing a loading profile is the trade-off between bandwidth and radiation efficiency. The merit of a particular profile is determined primarily by these performance measures. An examination of Figure 3 showed that the monopoles SWR curve is more or less flat from 36 to 150 MHz, with somewhat higher but still acceptable SWR from 12 to 36 MHz. The second measure of merit, radiation efficiency, is plotted in Figure 7. The efficiency is generally above 60% over the entire range 10 to 150 MHz, with only minor dips below 60%, and some regions where it is near or above 70%. Even the minimum efficiency value of 45% or so near 35 MHz is quite acceptable. The improved resistive load-



ing profile has produced an antenna with exceptionally good SWR bandwidth, relatively high power gain, and very acceptable radiation efficiency.

6. CONCLUSION

This article examined impedance-loaded wideband antenna elements and described a method of computing an improved loading profile. Adding resistance to an antenna can dramatically improve bandwidth, but doing so reduces radiation efficiency. The trade-off between greater bandwidth and efficiency is not arbitrary. Some loading profiles are much better than others for creating wideband antenna elements.

Previous theoretical calculations of suitable profiles provide a sound basis for loaded element design yielding very good results. But these studies considered only a special case of a travelling-wave current distribution. The improved loading profile described in this article results from extending the previous work to a power law travelling-wave current mode. Typical computer modeling results show that the improved profile provides better performance than previously used profiles. The technique for calculating the improved element loading promises to yield still better antennas in terms of bandwidth and efficiency, and will hopefully be put to good use to accomplish this goal.

7. LITERATURE

- [1] Willoughby, E. O., An Improved Wideband Aerial, Patent Spec'n No. 162,009, Commonwealth of Australia, 13th August, 1953.
- [2] Altshuler, E. E., The Travelling-Wave Linear Antenna, IRE Transactions on Antennas and Propagation, July 1961, p. 324.
- [3] Wu, T. T., and King, R. W. P., The Cylindrical Antenna with Non-reflecting Resistive Loading, IEEE Transactions on Antennas and Propagation, May 1965, pp. 369-373 (Corrections on p. 998, IEEE Trans. Ant. Prop., Nov. 1965)
- [4] Kanda, M., Time Domain Sensors for Radiated Impulsive Measurements, IEEE Transactions on Ant's and Propagation, May, 1983, p.438
- [5] Rama Rao, B. and Debroux, P. S., Wideband HF Monopole Antennas with Tapered Resistivity Loading, IEEE Military Communications Conference, Monterey, CA, Sept. 30 - Oct. 3, 1990 (MILCOM 90).
- [6] Rama Rao, B., Optimised Tapered Resistivity Profiles for Wideband HF Monopole Antenna, 1991 IEEE Antennas & Propagation Society International Symposium, London, Ontario, Canada.
- [7] Little, L., Ramabi, O., and Mittra, R., Combined Tapered Resistive and Inductive Loading to Increase the Bandwidth of Small Antennas, Proceedings of the IEEE Antennas & Propagation Society Symposium, July 1992, p. 2089.

The European Astronomers Club

Since November 1995 the European Astronomers Club has been actively in existence. It is also now the European Sub-Section of the Society of Amateur Radio Astronomers (S.A.R.A.).

The E.A.C. has been specifically formed to coordinate the efforts of all amateurs interested in Radio Astronomy, with a specific interest in helping newcomers to the field.

Special areas of interest are: Radio Solar work, General Radio Astronomy, Radio Meteor work, observation of the planets such as Jupiter and also in assisting amateurs in the Search for Extra-Terrestrial Intelligence (SETI).

If you are interested in learning more about the Club please send an A5 stamped addressed envelope together with 10 German Marks to:

Peter Wright B.s.c DJ0BI, Ziethen str 97, D68259 Mannheim, Germany

The Baltic DX Group

The Baltic DX Group was founded in 1993 by LY2BHP and LY2PX and a few others around the world. The concept of the Group is to promote Lithuania with a view to setting up low-cost holidays in LY. The first major meet was held in 1993 at Preila on the Courland Spit, a peninsula extending into the Baltic Sea. many people from all over the world attended, which set the future course for the BDX. In 1994 the main meeting was held at Birstonas in the south east of Lithuania and in 1995 the event was held in Palanga on the north west coast, a perfect family location and consequently the venue for the 1996 meeting.

As well as being a complete amateur radio station at the venue Palanga is THE holiday resort for all of Russia and is in the top corner of Lithuania (the hotel used in 1995 was in fact the ex-KGB holiday villa - although the only microphones found were connected to the amateur gear!). The 1996 event is planned for end July, early August. For more information about BDX please contact:

David Reid G0BZF, 5 Bridge Court, 100 Bridge Road, Chertsey, Surrey, KT16 8LX, UK. Tel: (0)1932 566435

**Email: G0BZF Dave 101454.3715@compuserve.com
LY2BHP Linas HOTEL@villion.cmail.compuserve.com**



Index of Volume 27 (1995)

Article	Author	Edition	Pages
ANTENNA TECHNOLOGY			
Calculating the Focal Point of an Offset Dish Antenna	Ing. Jiri Otypka, CSc	1995/1	25 - 30
A Big Wheel Antenna for the 70cm Band	Eugen Berberich DL8ZX	1995/2	123 - 126
AMATEUR TELEVISION			
Modifying Satellite Receiving Systems for 10 GHz FM ATV Operation	Denys Roussel F6IWF	1995/1	2 - 17
The World's Smallest 10 GHz ATV Transmitter	Angel Vilaseca HB9SLV Jean-Pierre Morel HB9RKR	1995/4	246 - 252
SATELLITE RECEPTION			
A DIY Receiver for GPS and GLONASS Satellites; Part-4	Matjaz Vidmar S53MV	1995/1	35 - 51
A DIY Receiver for GPS and GLONASS Satellites; Part-5	Matjaz Vidmar S53MV	1995/2	78 - 90
A DIY Receiver for GPS and GLONASS Satellites; Part-6	Matjaz Vidmar S53MV	1995/3	153 - 167
A DIY Receiver for GPS and GLONASS Satellites; Part-7 (conclusion)	Matjaz Vidmar S53MV	1995/4	194 - 205

6m BAND

A 28.50 MHz Transverter	Wolfgang Schneider DJ8ES	1995/2	107 - 111
-------------------------	-----------------------------	--------	-----------

2m BAND

A Bi-Directional Amplifier for 2m	Carl G. Lodström SM6MOM/W6	1995/1	18 - 21
--------------------------------------	-------------------------------	--------	---------

70cm BAND (see also the ANTENNA TECHNOLOGY section on page-31)

A 28/432 MHz Transverter	Wolfgang Schneider DJ8ES	1995/2	98 - 106
--------------------------	-----------------------------	--------	----------

13cm BAND

A 10 Watt Power Amplifier for the 13cm Band using GaAs Technology Developed with the help of 'PUFF' CAD software	Harald Fleckner	1995/4	217 - 228
---------------------------------------------------------------------------------------------------------------------------	-----------------	--------	-----------

3cm BAND

GaAsFET Power Amplifier Stages up to 5W for 10 GHz	Peter Vogl DL1RQ	1995/1	52 - 63
-------------------------------------------------------	---------------------	--------	---------

1.5cm BAND

200mW GaAsFET Amplifier for 24 GHz	Michael Kuhne	1995/3	130 - 146
---------------------------------------	---------------	--------	-----------

MEASURING TECHNOLOGY

The Detector for Complex Impedances - Some Practical Additions	Carl G. Lodström SM6MOM/W6	1995/1	22 - 24
----------------------------------------------------------------------	-------------------------------	--------	---------

A Grid-Dip Meter for VHF and UHF	Carl G. Lodström SM6MOM/W6	1995/2	70 - 77
-------------------------------------	-------------------------------	--------	---------

Frequency Counter with Harmonic Mixing for the UHF/SHF Amateur	Luis Cupido CT1DMK	1995/3	130 - 146
-------------------------------------------------------------------	-----------------------	--------	-----------

**MEASURING TECHNOLOGY (continued)**

Expansion and Assembly of the DB1NV Spectrum Analyser	Rainer Schmülling DK6ZK	1995/3	180 - 188
-------------------------------------------------------	----------------------------	--------	-----------

MEASURING TECHNOLOGY (continued)

New Software for the Digital Image Store for the DB1NV 010 Spectrum Analyser	Dr.Ing. Jochen Jirmann DB1NV	1995/4	229 - 230
Digital Display for the Logarithmic Detector Amplifier from DJ4GC	Norbert Kohns DG1KPN	1995/4	240 - 245

FUNDAMENTALS * NEW TECHNOLOGY

A Sweep Tuner for the VCO	Car G. Lodström	1995/2	66 - 69
Frequency Doubling using Semi-Conductor Diodes	Detlef Burchard Dipl.Ing.	1995/2	91 - 97
Linear Signal Rectification Part-1	Detlef Burchard Dipl.Ing.	1995/3	168 - 179
Linear Signal Rectification Part-2	Detlef Burchard Dipl.Ing.	1995/4	206 - 216

MISCELLANEOUS

Receiving System Parameter Measurements using Radio Stars	Hermann Hagn DK8CI	1995/2	112 - 122
A Simple DC-to-DC Down Converter for Amateur Radio Applications	Andreas Schaumburg DF7ZW	1995/4	231 - 234
First Amateur Cloud Scatter Beacon in Europe	François Cronauer LX1DU	1995/4	235 - 239

ADDITIONS TO OUR BOOK LIST

KM Publications now stocks a selection of ARRL books especially dealing with VHF and upwards and Antenna Design

	Price	UK	World
ANTENNA BOOK 17th Edition (c/w Software)	22.50	+3.30	+6.00
YAGI ANTENNA DESIGN	12.50	+1.50	+2.00
UHF/MICROWAVE EXPERIMENTERS MANUAL	16.00	+3.00	+3.75
UHF/MICROWAVE PROJECTS MANUAL	16.00	+2.50	+3.00
1995 ARRL HANDBOOK	22.50	+5.00	+7.25

Credit Card Orders +5% (for air mail delivery please enquire for cost)

KM Publications, 5 Ware Orchard, Barby, Nr.Rugby, CV23 8UF, UK

Tel: (0)1788 890365 Fax: (0)1788 891883

Email: vhf-comm@g6iqm.demon.co.uk or CompServe: 100441,377

ARRL QST Magazine

Now Available from KM Publications

£3.50 per issue p&p UK £1.00; Overseas £1.80

KM Publications, 5 Ware Orchard, Barby, Rugby, UK

Tel: (0)1788 890365 Fax: (0)1788 891883

The British Amateur Television Club

The foremost association on the world, for anyone, anywhere in the world, who is interested in Amateur Television.

CQ-TV the quarterly journal of the BATC is recognised as the most professionally produced amateur publication of its kind.

Join the BATC and receive *YOUR* copy of CQ-TV

Membership is *only* £9.00 per year.

BATC, Grenehurst, Pinewood Road, High Wycombe, HP12 4DD



Dipl.-Ing. Detlef Burchard, Box 14426, Nairobi, Kenya

Linear Signal Rectification

Part-3 (conclusion)

It was demonstrated in the earlier sections of this article that in passive rectification circuits [1], linear behaviour can not be expected below $\pm 2 * UT$. In active rectification circuits [2], this value can be reduced by several powers of ten by amplifiers if low frequencies are involved. Because of the limited amplification bandwidth product of any technical amplifier, there is an upper frequency limit for active rectifiers, which depends on the state of the art and at present is probably a few hundred MHz. Externally-controlled rectifiers have no non-linear range. They require components which can be purchased for frequencies of up to 5 GHz at relatively low prices. They are worth a closer look.

1. INTRODUCTION

A semiconductor diode must, so to speak, decide, from the polarity of the voltage across it whether it should

conduct or block. If this decision is taken in a different way in a "polarity detector", a switch can be controlled using this polarity logic signal. The switch is located in the path of the signal, and in one phase it lets the signal through normally and in the other it inverts it. This idea can be put into effect immediately with components from analogue computing technology. An example follows later - Fig.3.

However, very much higher frequency ranges can be reached with circuits which were already being used very early in the communications industry: ring modulators or ring mixers, which are now usually referred to as DBMs (double balanced mixers). The reason for this name, double balanced, is because both the control input and the signal input are balanced, which leads to an improvement in feedback effects and in carrier and harmonic suppression. There is also an active DBM which operates with differential amplifiers, which people are starting to describe as a Gilbert cell. It is scarcely any distance behind the standard passive DBM with regard to frequency range. It has been developed from multiplication

circuits used in analogue computing technology. If high accuracy is required at relatively low frequencies, such multiplier IC's are often a better choice than an active DBM.

Rectification and mixing with DBM's have a lot in common in both theory and practise. They are based on the multiplication of two signals. In rectification, the second signal has the same frequency as the first, but the amplitude must be constant. Especially if the amplitude is much higher than that of the first signal, and if the form is square, we can obtain a particularly clear type of behaviour. Linearity problems grow with signal voltage, but in contrast the behaviour is very linear at low, or very low, signal levels.

2. POLARITY DETECTOR

An amplifier with sufficiently high amplification will always change the polarity at its output if its input signal goes through zero. But there are limitations to this rule. It assumes that the amplifier has a very low input offset voltage, has no signal propagation time, and requires no recovery time following saturation. A standard operational amplifier certainly meets the first condition, but not the others. So it will operate as desired only at comparatively low frequencies. If its offset voltage can be adjusted and is constant, it can be brought down almost to zero, with the error being only a few microvolts.

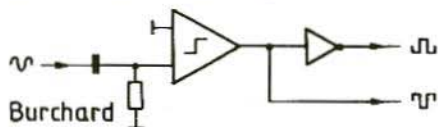

Fig.1: Polarity Detector with Two-Phase Output

Operational amplifiers which can be operated without frequency response correction would be more suitable for our task. Without the compensation capacitor, the recovery and propagation times improve by a factor of about 20.

Operational amplifiers can also be protected from undesired saturation by clamping diodes in the feedback. Or we can go straight over to a drain of differential amplifiers which have been dimensioned in such a way that none of the transistors used can become saturated. Such amplifiers can be found in pre-amplifiers for prescalers, limiters in intermediate-frequency IC's, or logarithmic converters. A useable limiter can be assembled even with the complementary stages of a CA 3600, whereas the similarly-wired CMOS module 4007 is usually unsuitable due to lack of bal-

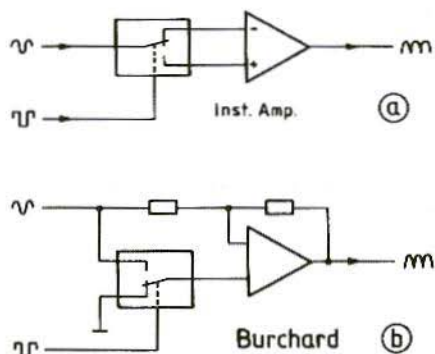

Fig.2: Controlled Rectifier with Analogue Switch

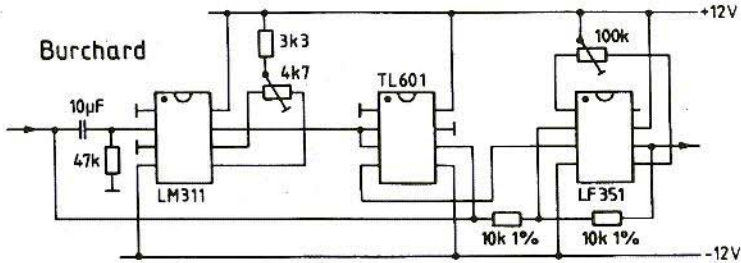

Fig.3: Dimensioned Circuit corresponding to Fig.2b

ance. It is important that as little phase shift as possible takes place between the input and the output.

Finally, there are also comparators which convert the zero crossing of the input voltage into a logic signal at the output, as desired, if the other input voltage is set at zero. Fig.1 shows a polarity detector of this kind. An inverter (for example) can be wired up after it if the complementary logic signal for balanced circuits is also required. Very fast comparators achieve response times of 0.2ns and are therefore suitable for frequencies of up to a few hundred MHz.

The AC voltage symbol \sim is henceforth used for the signal voltage, whilst the square wave symbol \square represents the logic signal - i.e. the control voltage for the rectifiers. Inverted signals are indicated by inverted symbols.

In some cases, the use of comparators alone will not lead to sufficiently low initial rectification voltages. For it is easy to see that rectification can not begin until a sufficiently high signal voltage is applied to the polarity detector. Perhaps a pre-amplifier should be inserted here. A de-coupled position is now available between it and the com-

parator, to which phase-correcting networks or selective circuits can be allocated. In the first case, the propagation time of pre-amplifier and comparator can be compensated. In the second, the noise bandwidth is reduced, so that lower signals can be rectified in a narrowed frequency band.

With a phase shift between signal and logic signal, there is a reduction in the output voltage in accordance with the cosine of the phase difference: $1/100 \cong 1/1000$ at 2.6°; 1% at 8.1°, and 10% at 26°. If the phase difference reads 90°,

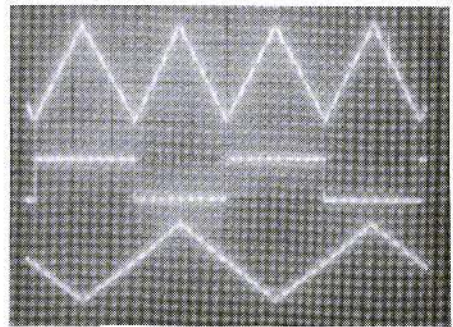

Fig.4: Characteristics of Circuit from Fig.3

- Y1: Output Voltage 20mV/div**
- Y2: Polarity Logic Signal 10V/div**
- Y3: Input Voltage 50 mV/div**
- X: 20 s/div**

AM is no longer de-modulated at all. The circuit has become a phase detector which recognises deviations of V from 90° . We know it from intermediate-frequency IC's for FM receivers.

3.

ANALOGUE SWITCH RECTIFIER

In the standard CMOS range, there is an assortment of analogue switches (4016, 4066, 4051...53), which are suitable for signal handling. They have no offset voltage and a good ratio of on to off resistances. With a circuit like that in Fig.2, they can switch the input signal to the other input of an instrumentation amplifier (a), or convert a standard operational amplifier in such a way that its amplification is changed from $+1$ to -1 (b). Neither circuit is balanced. The effect of this is that spikes from the logic signals cross over into the analogue section. A balanced structure could bring further improvements. Even as it is, the circuit already gives remarkable results in the low-frequency range. A test rig as per Fig.3, using standard commercial components, has a signal voltage range of at least 5mV to 10V_{pp} , and a frequency range going from almost zero to approximately 100kHz . The zero points for the comparator and the op-amp must be adjusted separately. A Texas Instruments analogue switch was used here, which can operate at $\pm V$, but which has rather poorer characteristics than the standard CMOS types referred to. The spikes can be clearly

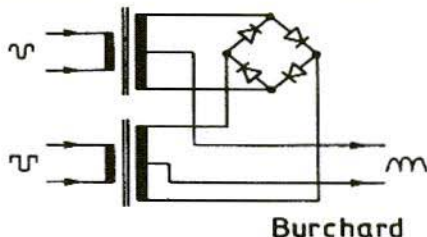

Fig.5: Passive DBM (Ring Modulator)

recognised on an oscillogramme showing the signal voltage, the logic signal and the output voltage (Fig.4). It is also easy to see that we are dealing with an instantaneous momentary value converter. With subsequent smoothing out, or if the output is not rapid enough for the doubled frequency, the output value corresponds to the mean value.

An integrated circuit operating on this principle can be obtained under the type name of AD 630 [3].

4.

RING MODULATOR

Fig.5 shows the ring modulator circuit, which has scarcely changed in 50 years. The signal and logic inputs have the same structure and are interchangeable. A large number of DBM's of this kind can be obtained nowadays from various manufacturers for all possible frequency ranges. They all have one thing in common. Zero point stability is neither specified nor guaranteed if the equipment is used as a rectifier. In reality, such a DBM can have a voltage error of several millivolts at the output.

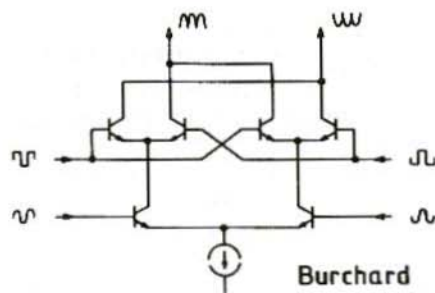

Fig.6: Active DBM (Gilbert Cell)

The diode current is made up of the switching current through the logic voltage and the signal current. If this last exceeds a specific level - about 20% of the switching current - a ring-modulator rectifier becomes markedly non-linear. There are similar disadvantages if it is used as a phase detector. For this reason, the DBM will be used only at the very highest frequencies where active DBM's fail. It is also for this reason that no circuits or type lists have been provided.

5. GILBERT CELL

If we take a somewhat closer look at the Gilbert cell circuit - Fig.6 - as described, for example, in [6] or [7], it is easy to see that this is a simplification of the active, double balanced mixers, MC 1496 and AD 533, as documented in [3] or [5], and as available on the market for some time already. The simplifications relate to savings on current sources and some external connections, which increase precision at low

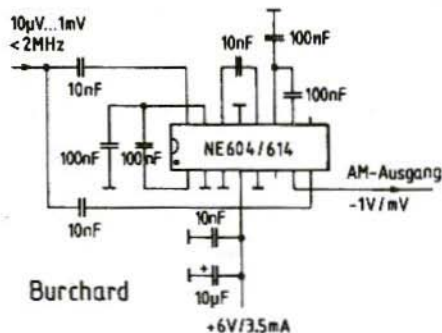

Fig.7: Linear AM De-Modulator, realised as Controlled Rectifier with an Intermediate-Frequency IC
Ausgang = Output

frequencies, make it possible to balance the offset voltages, and/or simplify scaling. The removal of circuits, and thus of capacities, increases the frequency range. Faster processes naturally also contribute towards this. Thus the SO 42 can be used up to 200 MHz, the NE 602 up to 500 MHz, and the IAM-81018 up to 5 GHz [4].

Likewise, the signal and logic inputs of the Gilbert cell are interchangeable. However, this alters the internal functioning. If the signals are applied as shown in Fig.6, then what we have below is a differential amplifier, the outputs of which can be exchanged with the four upper transistors, which operate as switches, as desired. If the signals are interchanged, then on top there are two differential amplifiers with parallel-wired inputs but with cross-wired outputs. Only one of them receives the emitter current at any one time, so that the assembly, on the one hand, amplifies the signal straight through, but, on the other hand, inverts the signal.

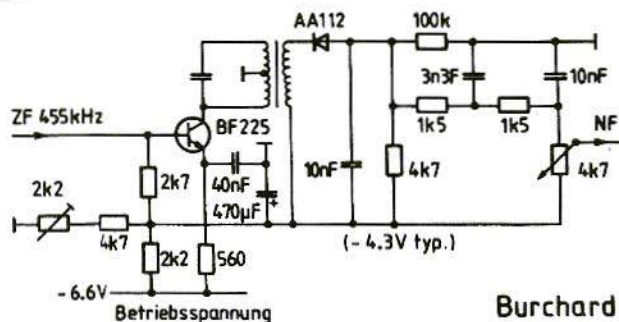

Fig.8:
Diode AM Demodulator,
Section of Circuit from
Barlow-Wadley MK III

Betriebsspannung =
Operating Voltage
ZF = IF
NF = AF

Burchard

Differential amplifiers of the type shown have a linear range of $\pm UT$ ($52mV_{ss} = 18mV_{eff}$). A voltage of $\pm 5 * UT$ ($260mV_{ss} = 90mV_{eff}$) is required for the complete changover of the constant current to the other transistor. This establishes the signal and logic voltages. In the MC 1496 and the SO 42, the signal voltage range can be extended through an external resistance, which simultaneously improves the linearity. With the AD 533, the linearity is not only better, because of internal compensation, but also guaranteed within narrow tolerances.

Rather than list numerous possible circuits, I shall show only one (Fig.7). Through the use of an intermediate-frequency IC, which was specifically designed for FM limitation and demodulation, a simple circuit is obtained with excellent AM de-modulator characteristics. The IC contains a five-stage limiter, with a sufficiently low phase error at up to 2 MHz. Tuning or phase shift can take place between the third and fourth stages (pins-12 and 14), to obtain even better results. The limited signal and the input signal are fed to the Gilbert cell which is present in the IC itself for de-modulation. It then comes out that the linear signal range goes up

to $1mV_{eff}$. This can be explained only by the assumption that there is another amplifier between the input (pin-8) and the Gilbert cell which amplifies by a factor of 18. It is true that the output is DC-coupled, but there is no temperature-stable reference. This circuit is therefore good for the de-modulation of double side band AM, but not for measuring purposes. The zero point would probably be dependent on the supply voltage and the ambient tem-

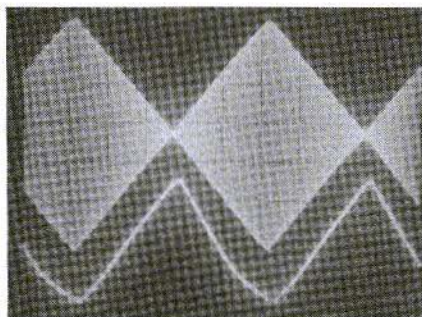

Fig.9: Characteristics of Circuit
from Fig.8

Y1: Receiver Input Signal,
Carrier 11 MHz,

Modulation 1 kHz; 0.1 mV/div

Y2: Audio Frequency at Volume
Control High Point, 0.2V/div

X: 0.2ms/div

perature. De-modulation starts as low as $10\mu\text{V}$. Thus an AM-modulated signal of 1mV may be 99% modulated.

For comparison purposes, Fig.8 shows the standard circuit for a diode de-modulator. If the final intermediate-frequency stage is included, it possesses just about the same number of components as Fig.7. The de-modulation values in Fig.9 are decidedly pathetic, which is due, not just to the passive circuit, but also to the dimensioning errors: increased damping of the resonant circuit as the high-frequency voltage increases, excessive load capacitance, different diode loads for AC and DC through the RC-RC filter chain.

6. CONCLUSION

Externally-controlled rectifiers can also be operated in such a way that the polarity logic signal is determined by a separate source. We then obtain a selective rectifier which is sensitive to the set frequency and to its odd harmonics - a search tone analyser. I have not regarded this application as signal rectification here.

Working with the Gilbert cell rectifier is certainly rewarding. I shall be undertak-

ing further tests, using it for measurement purposes at high frequencies. Due to the use of differential amplifiers, and through integration, significantly better zero point stability can be expected than with a passive DBM. Perhaps anyone who has already obtained some results would be kind enough to send them in for publication.

7. LITERATURE

- [1] D.Burchard (1994): Linear Signal Rectification - Part I
VHF Communications 3/1995,
pp. 168-179
- [2] D.Burchard (1994): Linear Signal Rectification - Part II
VHF Communications 4/1995,
pp. 206-216
- [3] Data Sheets AD 533 and AD 630
Analog Devices, Norwood
- [4] Data Sheet IAM-81018
Avantek, Santa Clara
- [5] Data Sheet MC 1496
Motorola, Phoenix
- [6] Data Sheet NE 602
Philips, Eindhoven
- [7] Data Sheet SO42
Siemens, München

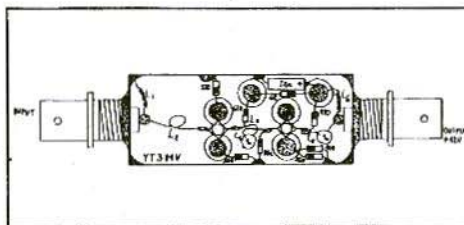

Very low noise aerial amplifier for the L-band as per the YT3MV article on page 90 of VHF Communications 2/92. Kit complete with housing Art No. 6358 £40.50. Orders to KM Publications at the address shown on the inside cover, or to UKW-Berichte direct. Price includes p&p



Richard A. Formato, Ph.D., K1POO

Design Parameters for Impedance Loaded Wideband Antennas

1. INTRODUCTION

Adding impedance loading (resistance and reactance) to an antenna is one of the most effective ways to increase its bandwidth. Since the early 1980s, this approach has received progressively more attention, and today it is state of the art for wideband systems. Choosing a suitable loading profile can maintain high radiation efficiency while providing a remarkable increase in bandwidth. One of the dipole designs in this article, for example, provides continuous coverage from 6 to 150 MHz with no tuner or matching network.

The question, of course, is how to select an optimum loading profile, because selecting the wrong one can produce dismal results. Indiscriminately adding resistance to an antenna obviously deteriorates performance, and the reduction can be quite severe. This article therefore analyses several key design param-

eters for selecting wire antenna loading profiles. Design guidelines are then developed to achieve the greatest antenna bandwidth. Some of the results are rather surprising, but they can lead to substantial performance improvements for loaded antennas.

The simplest loading scheme is to insert a resistor in the antenna. In the early 1960s, Altshuler [1] built a centre-fed dipole (CFD) whose input impedance was for practical purposes flat over a 2:1 frequency range as a result of added resistance. The antenna was loaded with a single 240 Ω resistor in each arm a quarter-wavelength from the end. Because resistance reduces the radiated power, the dipoles bandwidth was increased at the expense of radiation efficiency, which was reduced by about 50%. This is the inevitable trade-off in designing impedance loaded wire antennas. Bandwidth is best in heavily loaded antennas, but the resulting penalty in radiation efficiency may be too high to provide acceptable power gain (product of directive gain and efficiency).



A few years after Altshuler's work, Wu and King [2] published a theoretical model of the loaded CFD. Unlike the discrete resistor approach, the Wu and King loading profile varied continuously along the antenna and could be implemented with a conductive surface layer of different materials (aluminium and carbon, for example) of varying thickness. Profiles based on the Wu-King (WK) theory, which requires a travelling wave current mode with a linear amplitude decay, provide good bandwidth but relatively poor radiation efficiency because the antenna is heavily loaded.

An example of what can be achieved is the wideband field probe for sampling impulsive electromagnetic fields built by Kanda [3]. A CFD probe was designed using the WK profile. It was resistively and capacitively loaded by depositing on a glass rod substrate a segmented, conductive thin-film of varying thickness. Narrow rings were burned away using an argon laser to separate the conductive segments, thereby providing the reactive component of the loading profile. Although the loaded CFD was useful as a field probe, it was not useful as a transmitting antenna because it was so inefficient (transfer function typically below -22 dB).

Attempts have been made to increase the efficiency of impedance loaded antennas. Rama Rao and Debroux [4, 5], for example, developed a more efficient HF monopole antenna by using a fractional WK profile. Efficiencies of 15%-36% with $SWR \leq 2$ were achieved from 5-30 MHz in a 35-foot high antenna. The monopole was continu-

ously loaded with a profile equal to 30% of the WK profile, and a fixed, lumped-element matching network was inserted at the antenna feed point.

Still better bandwidth and efficiency can be achieved by using an improved loading profile derived from a travelling-wave current mode with a *power law* amplitude decay, instead of the linear decay required by the WK profile. The derivation of the improved profile and its relationship to the WK profile are developed by Formato [6]. The non-linear amplitude decrease of the current along the antenna results in a higher average antenna current, which, in turn, increases the radiated fields and total radiated power. The antenna's radiation efficiency is higher because it radiates more of the input power.

There are several parameters that influence how well a particular loading profile performs, and there is not one "best" profile. Important design parameters include: (1) value of the power law exponent; (2) design frequency; (3) wire length-to-diameter ratio; and (4) number of antenna segments (number of discrete resistors). Certain parameters are more important than others (in the sense of having a relatively greater impact on performance), and for some parameters the results are unexpected.

These four design parameters are discussed below for typical HF/VHF centre-fed dipole antenna designs. Radiation efficiency and SWR are examined for RF source frequencies between 2 and 150 MHz (the upper limit of the computer model). There are, of course, other important measures of antenna performance (power gain and pattern,

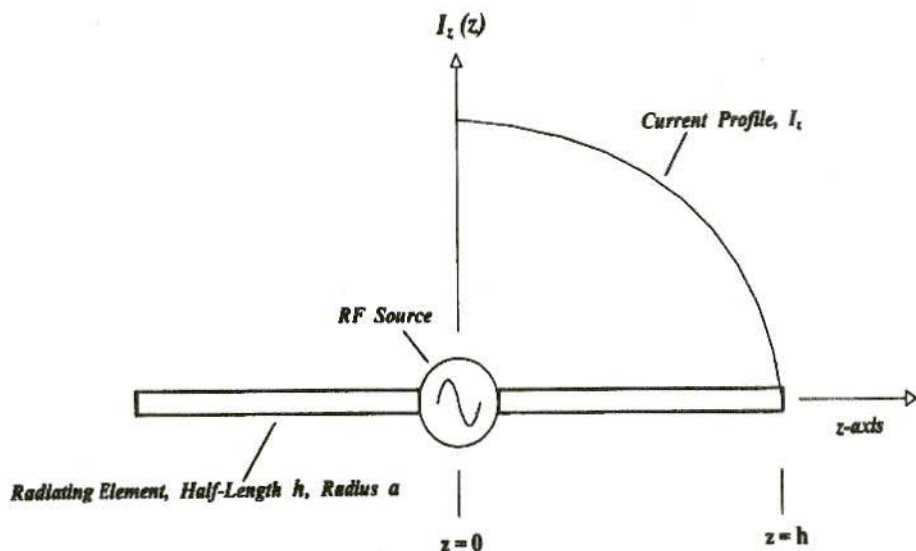

Fig.1: The Centre-Fed Dipole

for example), but these are not examined in detail because they are usually acceptable in an impedance-loaded antenna with a good loading profile.

2. CONTINUOUS LOADING PROFILES

Figure 1 shows the centre-fed dipole (CFD) antenna. It consists of two wire radiating elements with half-length h and radius a . The total dipole length is $L=2h$, and its diameter is $D=2a$. The amplitude of the current profile is plotted schematically along one elements length. Maximum current occurs at the RF source at the feed point, and it decreases along each arm until reaching zero at the end.

The CFDs bandwidth is increased by symmetrically loading it with an internal impedance profile (resistance and reactance). The profile is given by:

$$Z^i(|z|) = R^i(|z|) + jX^i(|z|), \quad |z| \leq H$$

where Z^i is the (complex) internal impedance per unit length (ohms/meter) consisting of lineal resistance R^i and reactance X^i , and where $j = \sqrt{-1}$.

The resistance and reactance per unit length for the improved power-law impedance profile are given by:

$$R^i(z) = 60 \nu (h-|z|)^{\nu-2} \left\{ \psi_R - \frac{(1-\nu) \psi_I}{2k_o (h-|z|)} \right\} \quad (1a)$$

$$X^i(z) = 60 \nu (h-|z|)^{\nu-2} \left\{ \psi_I + \frac{(1-\nu) \psi_R}{2k_o (h-|z|)} \right\} \quad (1b)$$



where $k_0 = (2\pi / \lambda_0)$ is the wave-number. λ_0 is the free-space wavelength corresponding to the design frequency, which is designated f_0 . ν is the power-law exponent (profile exponent) for a travelling-wave current distribution that minimises resonance effects. Equation (1) recovers the 100% WK profile when $\nu = 1$. The general case corresponds to $\nu \leq 1$. The derivation of equation (1) and its relationship to previous work are discussed in [6].

The reactance computed from equation (1b) can be positive (inductive) or negative (capacitive). The lineal inductance (henry/meter) or capacitance (farad/meter) are given by:

$L_i = X_i / 2\pi f_0$ and $C_i = (2f_0 X_i)^{-1}$ for $X_i > 0$ and $X_i < 0$, respectively, where the design frequency f_0 is in Hertz.

$\psi = \psi_R + j\psi_I$ in equation (1) is a complex quantity known as the *expansion parameter* [1, 2], its real and imaginary parts being subscripted R and I, respectively. ψ is the ratio of the CFDs vector potential to current, which is approximately constant along its length. The expansion parameter is defined as [2]

$$\psi = 2 \left[\sinh^{-1} \left(\frac{h}{a} \right) - C(2k_0 a, 2k_0 h) - jS(2k_0 a, 2k_0 h) \right] + \frac{j}{k_0 h} [1 - \exp(-j2k_0 h)] \quad (2)$$

C and S are the generalised sine and cosine integrals [2, 7] given by

$$C(b, x) = \int_0^x \frac{1 - \cos W}{W} du \quad (3a)$$

$$S(b, x) = \int_0^x \frac{\sin W}{W} du \quad (3b)$$

where $W = (u^2 + b^2)^{1/2}$.

Because ψ is frequency dependent, it is usually evaluated at the antennas fundamental half-wave resonance, that is, $\lambda_0 = 4h$ (see [2] for details). As discussed below, however, this choice does not necessarily provide the best antenna performance. The design frequency f_0 (in Hertz) and the wavelength λ_0 (in meters) are related by $f_0 \lambda_0 = c$, where $c \cong 2.998 \times 10^8$ meters per second is the free-space velocity of light.

The improved loading profile specified by equation (1) in general contains both resistance and reactance. But adding reactance to a wire antenna, especially capacitive reactance, can complicate construction. As a consequence, many practical designs employ only resistive loading, because excellent results are often achieved even without the loading profiles reactive component (see [4] and [5], for example). In the CFD designs discussed below, only resistive loading is therefore considered.

3. DISCRETE LOADING

Building a continuously-loaded antenna can be a formidable task, especially if some exotic technique is required (for example, vapour deposition of a con-

ductive thin-film layer), or if reactive loading is included. An effective alternative is to construct an approximation to the continuous loading profile using discrete resistors at intervals along the antenna. The antenna is constructed of highly conducting (for practical purposes, perfectly conducting) cylindrical wire segments that are connected together by resistors. Single resistors can be used, or, for large diameter radiators, multiple resistors may be employed. This type of discrete loading profile can provide excellent bandwidth and efficiency, better even than a continuous profile, and it does so without the problems associated with continuous profiles or reactive loading. Because of these advantages, only discrete loading profiles are considered in this article.

A discrete profile may be determined by first dividing the CFD into an *odd* number of equal length segments, N . The centre segment, which contains the RF source, is not loaded. All other segments are loaded with a lumped resistance placed at the segment centre. The

value of the resistor is computed as the product of the segment length (in meters) and the value of the continuous loading profile evaluated at the segment centre [R^i in ohms/meter from equation 1(a)]. This approach provides a piecewise linear (step) approximation to the continuous loading profile. There are, of course, any number of other discrete

approximations, but only this uniform step approximation will be considered here.

As an example of a typical discrete profile, consider a CFD with the following design parameters: $L = 22$ m; $D = 10$ cm; $f_0 = 7$ MHz; $v = 0.4$; $N = 29$; $\psi = 8.822 - j2.464$. There is no reactive loading or feed point loading, and the full profile (100%) is used. The discrete resistance-only profile, computed as described above for $z \geq 0$, is tabulated below. Distance is measured from the origin, and the loading is symmetrical in each arm of the CFD. The loading resistance increases slowly from 3.86Ω on either side of the RF source (0.76 meter from the centre) to just over 438Ω in the last segment (located ± 10.62 meters from the source). This very gradual increase in resistance is typical of more efficient loading profiles.

Distance (m)	Resistance (Ω)	Distance (m)	Resistance (Ω)
0.00	0.00	5.31	9.82
0.76	3.86	6.07	12.30
1.52	4.36	6.83	15.99
2.28	4.98	7.59	21.89
3.03	5.76	8.34	32.31
3.79	6.75	9.10	53.90
4.55	8.05	9.86	113.47
		10.62	438.06

In the sections that follow, several antenna design parameters are investigated by examining the computer-modelled performance of a typical 22 meter long CFD using discrete resistance-only loading.

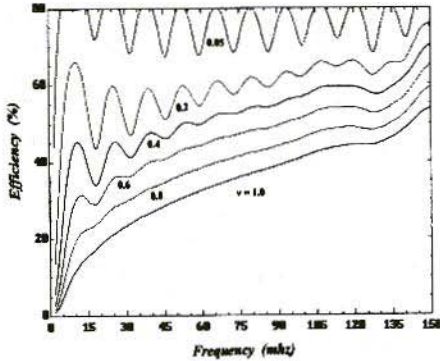

Fig.2: Radiation Efficiency

4. POWER LAW EXPONENT

Probably the most important design parameter in determining radiation efficiency is the value of the profile exponent, ν , which determines how quickly the current amplitude decays along the dipole. Slower decay (lower ν) results in a higher average antenna current, which increases the radiated fields and consequently the efficiency. The efficiency improvement can be quite dramatic. The trade-off is that decreasing increases the peak standing-wave ratio (SWR) and causes it to fluctuate more with frequency.

The influence that ν has on radiation efficiency and SWR is illustrated in Figures 2 and 3. These plots are based on computer-modelled data for a 10 cm diameter, 22 meter long CFD with $N=29$ and a 100% resistance-only loading profile computed at a design frequency of 7 MHz (approximately the fundamental resonance). Efficiency and SWR are plotted as a function of the RF source frequency from 2 to 150 MHz.

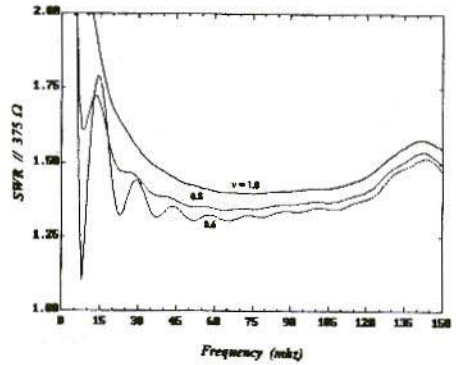

Fig.3a: Standing Wave Ratio
 $\nu = 0.6, 0.8 \text{ \& } 1.0$

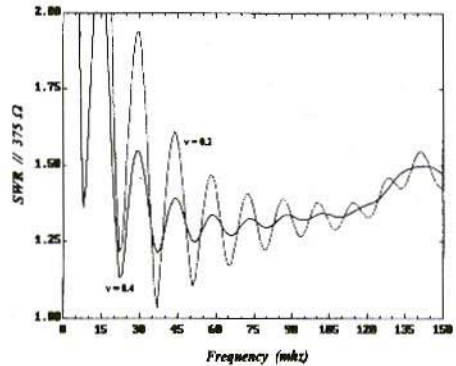

Fig.3b: Standing Wave Ratio
 $\nu = 0.2$

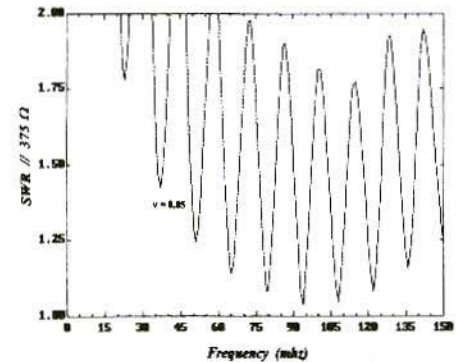

Fig.3c: Standing Wave Ratio
 $\nu = 0.5$



Calculations were made every 1 MHz.

The profile exponent ν has a very significant effect on radiation efficiency, with lower values resulting in higher efficiencies. The curve in Figure 2 for $\nu = 1$, which corresponds to the 100% WK loading profile, shows that the efficiency increases from about 1% at 2 MHz to about 54% at 150 MHz.

The variation with frequency is smooth and monotonic. But as ν decreases, the efficiency increases progressively more rapidly, especially at lower frequencies. When $\nu = 0.2$, the efficiency increases from about 14% at 2 MHz to more than 65% at 10 MHz, a 51% increase in a span of only 8 MHz. Beyond 10 MHz, the efficiency fluctuates more or less periodically, with a gradually increasing trend until it reaches a maximum above 75% at 150 MHz. For $\nu = 0.05$, the efficiency exhibits a pronounced quasi-periodic fluctuation; but its minimum value is more than 68%, and the maximum is well above 80%.

Figure 3 plots SWR parametric in for an RF source characteristic impedance of 375Ω . If a different feed system impedance is used, an appropriate broadband transformer would be required. For $\nu = 1.0$, the SWR varies smoothly from a maximum of greater than 2:1 at 12 MHz to a minimum of about 1.45 near 67 MHz. It then increases gradually above 67 MHz with a slight dip near 150 MHz.

The curves for $\nu = 0.8$ and 0.6 show the same general trend. But, significantly, the SWR is generally lower with decreasing ν , even though it fluctuates more at lower frequencies.

Figure 3(b) plots the SWR for $\nu = 0.4$ and 0.2. The SWR is generally lower for $\nu = 0.4$ than it is for $\nu = 0.6$, but the variability with frequency is much greater, and the peak values are higher at some frequencies. For $\nu = 0.4$, the SWR exceeds 2:1 between about 12 and 16 MHz, but it is below 2 for $\nu = 0.6$. As ν decreases to 0.2 and then to 0.05, Figure 3(c), the SWR fluctuation becomes more pronounced, and the peak values are higher. The minimum SWR values, however, are generally lower, and, on the average, the SWR is still well below 2:1.

The best choice for ν is evidently the lowest value that provides acceptable SWR at frequencies of interest. Choosing ν in this way insures the highest possible radiation efficiency, and the improvement is usually very substantial.

5. DESIGN FREQUENCY

The design frequency f_0 is another important parameter in determining a good loading profile. Although it appears to be accepted practice to choose f_0 close to the CFD half-wave resonance frequency (see [2], for example), this choice is not necessarily the best. Because the expansion parameter, which plays a major role in determining the loading profile, is frequency-dependent, the actual choice of design frequency must be based on how much a given loading profile improves bandwidth while still providing good radiation

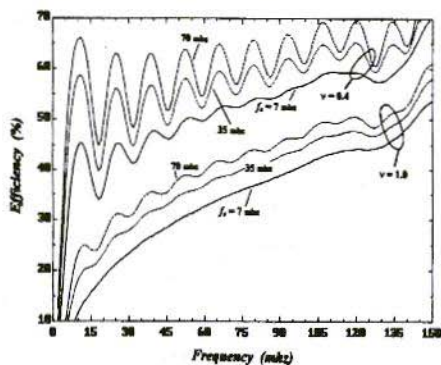

Fig.4: Radiation Efficiency

efficiency. There is no other sensible scheme for determining f_0 because there is no theoretical basis for choosing one value over another. The best approach is therefore empirical, which is the approach adopted here.

Radiation efficiency and SWR plots for three design frequencies and two values of the profile exponent are shown in Figures 4 and 5 for a 22 meter long, 10 cm diameter CFD with $N=29$ and a 100% resistance-only loading profile. Values of 7 MHz (approximately the half-wave frequency), 35 MHz, and 70 MHz were used for f_0 , with $v=1.0$ and 0.4 at each frequency. Except for the fundamental resonance, f_0 was chosen arbitrarily. Other choices would yield different results, but the observations made here are still generally applicable.

As expected, the lowest efficiencies in Figure 4 result from the most heavily loaded profile ($v=1.0$). The efficiency increases with frequency and shows slightly more variability at the higher design frequencies. The less heavily loaded profile ($v=0.4$) is much better, especially between 2 and 10 MHz.

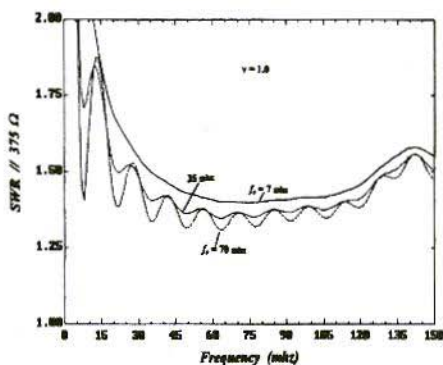

Fig.5a: Standing Wave Ratio
 $v = 1.0$

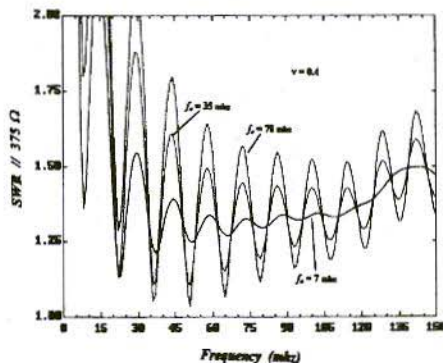

Fig.5b: Standing Wave Ratio
 $v = 0.4$

The higher values of f_0 increase the fluctuation in the efficiency, but the variability is not great.

The most important feature of the efficiency data is that *higher* design frequencies result in substantial improvements. f_0 has a major impact on radiation efficiency, and its influence is greater for profiles with lower values of v . Because the efficiency increases with decreasing v , the influence that f_0 has becomes even more important. Thus, even though the 22 meter CFD has a

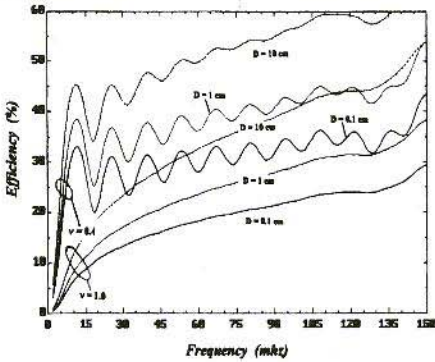

Fig.6: Radiation Efficiency

fundamental resonance near 7 MHz, choosing a design frequency that is *10 times greater* provides better performance. For example, as the curve for $\nu = 0.4$ shows, the radiation efficiency at 10 MHz is about 45% when $f_0 = 7$ MHz, but it increases to 67% when f_0 is increased to 70 MHz. Choosing a higher design frequency thus results in a much better antenna.

The advantage of a higher design frequency is also evident in the SWR plots of Figure 5. It is quite significant that selecting $f_0 = 70$ MHz when $\nu = 1.0$, Figure 5(a), results in generally the lowest SWR across the entire 2 to 150 MHz band.

When $\nu = 0.4$, Figure 5(b), choosing $f_0 = 70$ MHz results in $\text{SWR} \leq 2$ across most of the band. The variability is greater, and the SWR is not consistently lower with increasing f_0 , as it is when $\nu = 1.0$.

These effects are minor, however, and better overall performance usually results from higher values of f_0 .

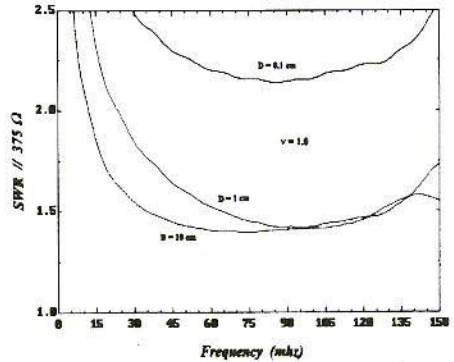
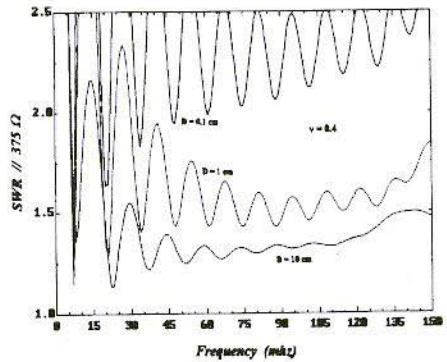
Fig.7a: Standing Wave Ratio
 $\nu = 1$ Fig.7b: Standing Wave Ratio
 $\nu = 0.4$

6. RADIATING ELEMENT LENGTH-TO-DIAMETER RATIO

Performance data for various L/D ratios appear in Figures 6 and 7. Radiation efficiency and SWR were computed for radiating element diameters of 0.1 cm, 1 cm, and 10 cm with profile exponents of $\nu = 1.0$ and 0.4. The corresponding L/D ratios are 22000, 2200 and 220,



which represent antennas ranging from "extremely thin" to "thin". The CFD is 22 meters long with 29 segments and a 100% resistance-only loading profile computed at a design frequency of $f_0 = 7$ MHz.

Increasing the element diameter is a standard broadbanding technique for wire radiators. It is therefore not surprising that a larger diameter, impedance-loaded CFD exhibits better overall performance than its thin counterpart. In Figure 6, for example, larger diameter antennas have better radiation efficiency at all frequencies for both values of v . The improvement in efficiency becomes progressively greater at higher frequencies, and it approaches a factor of 2 at the high end of the band. For the profiles with $v = 0.4$, increasing the element diameter also reduces fluctuations in the efficiency curve. The curve for $D = 10$ cm, for example, is much flatter than the curve for $D = 0.1$ cm. This effect is not evident in the heavily loaded profiles when $v = 1.0$.

SWR curves for $v = 1.0$ appear in Figure 7(a). The largest diameter element provides the best performance, especially at lower frequencies. Its SWR is below 2.5 at all frequencies above 6.5 MHz, and below 2 above approximately 12 MHz. The SWR decreases quickly up to about 30 MHz and flattens out below 1.5:1 for most of the rest of the band. By contrast, SWR for the very thin element ($D = 0.1$ cm) is high, being above 2 throughout the band, and above 2.5 below 30 MHz. The very thin radiator thus fails to provide acceptable SWR even though it is very heavily loaded.

Similar SWR behaviour appears in the curves for $v = 0.4$ in Figure 7(b). The fattest element provides the best performance. Its SWR is below 1.5 over most of the band, and below 2.15 at all frequencies above 6 MHz. Decreasing the diameter to 0.1 cm increases the SWR, but not as much as it did for the more heavily loaded profile with $v = 1.0$. When $v = 0.4$, however, the SWR variability becomes much more pronounced for smaller element diameters.

Building an antenna with a low L/D ratio, that is, making it "fatter", may be difficult if too large a diameter conductor is required. Fortunately, a continuous cylindrical surface can be frequently approximated by a sufficient number of parallel wires (usually ≥ 6) uniformly spaced around the cylinders circumference. This dipole structure, sometimes called a "cage dipole" because of its resemblance to a bird cage, offers a convenient and effective alternative to large diameter cylinders for low L/D ratio designs.

7. SEGMENTATION

Radiation efficiency and SWR data for different segmentation (values of N) appear in Figures 8 and 9, and the results are somewhat unexpected. A 22 meter long, 1 centimetre diameter CFD was modelled with $N = 29, 59$, and 119 segments. A 100% resistance-only loading profile with $v = 1.0$ and 0.4 was computed at a design frequency of $f_0 = 7$ MHz.

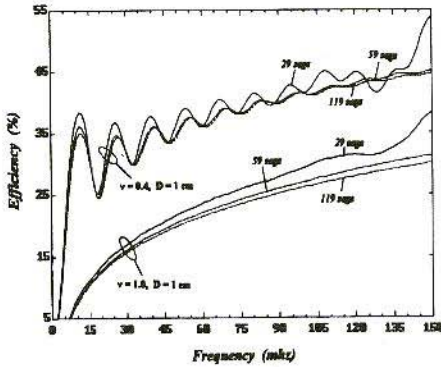

Fig.8: Radiation Efficiency

The efficiency curves in Figure 8 show that the least segmented antenna ($N = 29$) provides the best overall performance. As the segmentation increases, radiation efficiency generally decreases, although the change is not great from $N = 59$ to 119 . This result is somewhat surprising, since increasing segmentation presumably provides a better approximation to the continuous loading profile. However, the data shows quite convincingly that the net effect of adding more discrete resistance is to increase the i^2R (Joule heating) losses more than the radiated power, resulting in lowered efficiency. This effect occurs for both values of the profile exponent v . As is typically the case, the efficiency fluctuates more with frequency as decreases, and the variability is greatest at the low end of the band. One effect of increasing N is to reduce the fluctuation somewhat, but the change is not pronounced, and it occurs only when $v = 0.4$.

The SWR data in Figure 9 are not as clear cut as the efficiency data in Figure 8, but the general conclusion is still that the lowest segmentation probably provides the best overall performance. For

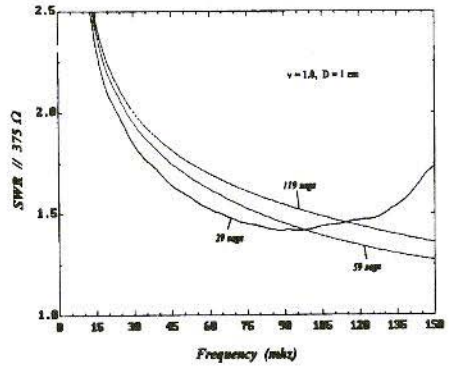

Fig.9a: Standing Wave Ratio
 $v = 1, D = 1 \text{ cm}$

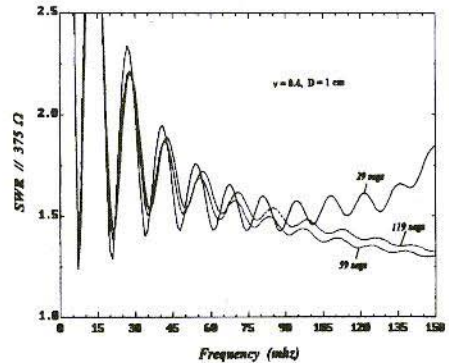

Fig.9b: Standing Wave Ratio
 $v = 0.4, D = 1 \text{ cm}$

$v = 1.0$, the SWR is lowest for $N = 29$ at frequencies below approximately 90 MHz (about a factor of 12 greater than the fundamental resonance). In the same frequency range, it is not significantly different from the $N = 59$ or 119 values even when $v = 0.4$. Above 90 MHz, the antenna with $N = 59$ performs best for both values of v , but the 119 segment design is very close. Nevertheless, in that same frequency range, "eyeball average" SWRs for $N = 29$ are, say, 1.6 for $v = 1.0$ and 1.65 for $v = 0.4$, which are very good



indeed. Thus, the least segmented antenna provides very robust SWR performance at all frequencies from 2-150 MHz.

8. CONCLUSION

This article has investigated four design parameters for impedance-loaded wide-band wire antennas. Using the following guidelines to select these parameters when designing an impedance loading profile should provide a near-optimum wideband antenna:

- (a) The profile exponent ν is very important in determining radiation efficiency. Lower values of result in higher efficiencies, and the improvement is very significant. The optimum value for ν is the smallest value that provides acceptable SWR at frequencies of interest.
- (b) Because the design frequency f_0 is usually chosen close to the fundamental CFD resonance, it is somewhat surprising that *higher* frequencies generally result in much better radiation efficiency, especially for loading profiles with smaller values of ν .

Higher values of f_0 also usually give better overall SWR performance. The optimum value for f_0 is the highest value that provides acceptable SWR at frequencies of interest.

- (c) The lower the L/D ratio, the better. Large diameter radiating elements provide much more bandwidth than thin ones even without impedance loading. A large diameter radiator makes it easier for a loading profile to provide the greatest possible bandwidth. If necessary, large diameter conductors can be approximated by multiple parallel wires.
- (d) Reducing the segmentation, that is, the number of discrete resistors used to approximate the theoretical continuous loading profile, results in slightly better radiation efficiency.

The SWR is not particularly sensitive to segmentation at "low" frequencies, and it is slightly better with increased segmentation at "high" frequencies. For a thin antenna, "low" frequencies are less than about 12 times the fundamental resonance, and "high" frequencies are greater.

The design guideline for segmentation is to use the smallest number of discrete resistors that meets the SWR objectives.

9. LITERATURE

- [1] Altshuler, E. E., The Travelling-Wave Linear Antenna, IRE Transactions on Antennas and Propagation, July 1961, p. 324.



- [2] Wu, T. T., and King, R. W. P., The Cylindrical Antenna with Non-reflecting Resistive Loading, IEEE Transactions on Antennas and Propagation, May 1965, pp. 369-373 (see also Corrections, p. 998, IEEE Trans. Ant. Prop., Nov. 1965)
- [3] Kanda, M., Time Domain Sensors for Radiated Impulsive Measurements, IEEE Transactions on Antennas and Propagation, May, 1983, p. 438.
- [4] Rama Rao, B. and Debroux, P. S., Wideband HF Monopole Antennas with Tapered Resistivity Loading, IEEE Military Communications Conference, Monterey, CA, Sept. 30 - Oct. 3, 1990 (MILCOM 90).
- [5] Rama Rao, B., Optimised Tapered Resistivity Profiles for Wideband HF Monopole Antenna, 1991 IEEE Ant. & Prop. Soc. Symposium, London, Ontario, Canada.
- [6] Formato, R. A., Improved Impedance Loading for Wideband Antennas, 1995 Richard A. Formato. VHF Communications 1/1996, pp.20-
- [7] Abramowitz, M., and Stegun, I., Handbook of Mathematical Functions With Formulas, Graphs, and Mathematical Tables, U.S. Department of Commerce, National Bureau of Standards Applied Mathematics Series 55 (AMS 55), Ninth Printing, November 1970, p. 231.

The Parabolic 24cm Preamplifier

A fully weather-proofed very high-quality preamplifier covering 1200 MHz to 1360 MHz. Mounted in a sealed diecast enclosure with weatherproof N-type sockets for input and output. DC powered via the output socket for remote mast-head mounting.

GAIN >40dB across the band
NOISE FIGURE <1.6dB

£130 + £7.50 post and packing

**KM Publications, 5 Ware Orchard, Barby, Nr.Rugby,
CV23 8UF, U.K.**

Tel: (0)1788 890 365 Fax: (0)1788 890 365

ALL MAJOR CREDIT CARDS ACCEPTED



Michael J Wooding, G6IQM

Filtech Professional

A Review

Dabbling a little in electronics as I do I have in the past designed filters the hard way - you know:

- 1) decide on the type of filter best suited to the problem in question;
- 2) work out the theoretical values of the components by mathematical analysis;
- 3) glue the bits together;
- 4) put the circuit on a network analyser and then;
- 5) go back to stage 1 and start again!

Now I know that there are far cleverer engineers than me, but I equally know that there are many of you out there who use the above method, going round and round until the desired result, or a close approximation of it, is produced. However, help is at hand. Reach for your trusty PC and run *Filtech* or *Filtech Professional* from *Number One Systems*, or if you have not yet purchased your copy, read on and see what you are missing!

1. FILTECH

Filtech and *Filtech Professional* are advanced circuit synthesis programs that produce both active and passive filter circuits from your specifications. With no mathematics or tedious manipulation of tables required, these programs make the design of complex filter circuits fast, simple, accurate and in terms of development time, very cost effectively.

All that you need to specify for your filter are the frequency limits for the type of filter (i.e. lowpass, highpass, bandpass or bandstop), the stopband attenuation required and the maximum acceptable passband ripple. Then simply run the program, fine tune the design if required and the filter is simulated and designed for you, including all the component values.

Both versions of the program include a built-in circuit simulator allowing you to test the circuit immediately, compar-



ing the simulated result with the original specification. As with all computer design programs the values calculated for the components are real and not necessarily preferred values. However, you can force the program to select components to the nearest preferred value from a list of different ranges and check the effect on the filter performance at a glance.

Filtech can design Bessel, Butterworth and Chebyshev filters up to 6th order types, whereas the enhanced version *Filtech Professional* can design the above plus Caur (elliptic) up to 12th order filters.

The essential features of *Filtech* are:

- Passive Filter design
- Bessel, Butterworth and Chebyshev to 6th order in *Filtech*
- Bessel, Butterworth, Chebyshev and Caur (elliptic) to 12th order in *Filtech Professional*
- Active Filter design
- Sallen & Key and BiQuad
- LowPass, HighPass, BandPass & BandStop
- Graphical Display of Specification
- Built-in Simulator includes Source and Load Impedances
- Overlays Simulated Performance on Specification
- Seamless Link to Analyser III if present
- Optionally Forces Values to Nearest preferred Value

- Results Available as either a Netlist or Text Listing

The computer requirements for running either version of the program are an IBM PC or clone running under MS-DOS version 3 or later, an EGA or VGA screen and a minimum of 640k of RAM. To use all of the features of the program a mouse is also required. Supported printers are 9 or 24-pin Epson or IBM Graphics printers, Laserjet II Laser printers or equivalent. The programs will also run as DOS applications under Windows 3 and 3.1, Windows for Workgroups 3.11 and Windows 95 (and probably Windows NT as well, but as I don't run that version I cannot say for sure).

2.

DOCUMENTATION

As with all Number One Systems software packages these programs come with an extensive instruction manual in A5 binder format. This manual follows their well tried and tested format of a program Overview, followed by installation Instructions, a chapter on First Impressions, the Grand Tour, a Reference section, a chapter detailing Customisation, Netlist formats, linking to Analyser III (AC Circuit Simulation software package from Number One Systems), a chapter on Filter Design and numerous appendixes of filter circuits relating to *Filtech* designs.

The program *Overview* and *Installation* chapters are concise and detail the

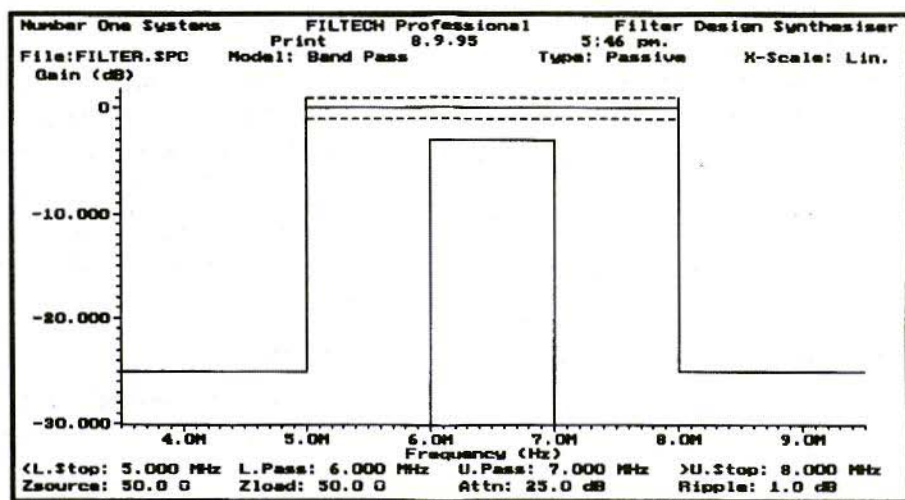

Fig.1: The Opening Design Screen

essential properties of the software and all you need to know to load it onto your hard drive.

The *First Impressions* chapter is in reality not just a quick tour of the major components of the programs, but actually a tutorial on the basic aspects of running the package and producing filter designs to example specifications, and reviewing how to fine tune a specification for the real world.

The chapter *Grand Tour* now takes you step-by-step through all the functions of the software at least once, guiding you through detailed filter design simulations producing working filter specifications for practical filters.

The *Reference* chapter describes in greater detail the options of the Specify, Parameters and View menus and how and when to use the powerful features available.

The *Customising* chapter allows you to configure the package specifically for

your system and operation. The appendixes give information on various aspects of running the software in association with other packages and DOS, detailed information on filter design aspects and all the circuits that *Filtech* uses in its simulations.

3. RUNNING FILTECH

Filtech is essentially a DOS package, but as stated earlier runs perfectly well as a DOS application within Windows 3, etc. To run from windows of any ilk nothing more than creating an Icon (in Windows 95 a Shortcut to the *.exe program) is necessary. For those of you like me who are graphically oriented, there is no icon provided for Windows so you just have to be inventive. For Windows 95 users nothing need be



changed in the properties of the shortcut, unless of course you want to, but *Filtech* runs perfectly well in a standard DOS window without modification.

Upon execution of the program you are presented with the design screen as shown in Fig.1. The screen is essentially a piece of graph paper on which the spectrum of the filter performance will be plotted. At the top of the screen is the familiar tool bar of drop-down menus and at the bottom of the screen is an array of user-variable filter parameters.

The drop-down menus are:

Configuration; Specify; Parameters; View; !Tools; Help; Quit; File; Model; Type and X-scale.

- *Configuration*: this menu deals with the path settings, file parameters and general hardware settings for the program, printing, etc.
- *Specify*: this menu is a sort of non-menu! What selecting this feature does in fact is to return you to the original design screen, which then allows you to change any of the settings and parameters prior to running the simulation again.
- *Parameters*: this menu allows you to select the style of filter to be designed (i.e. Chebychev, Butterworth, etc.), the allowable ripple and the order of filter.
- *View*: this is the all-action selection box. Clicking on this item runs the simulation software and plots on the screen the actual spectrum of the filter as determined by the parameters previously entered.
- *!Tools*: this menu gives access to basic DOS tools and also give the facility to print a Netlist for the designed filter (a Netlist is a list of components and their values and circuit specifications, etc.).
- *Help*: not surprisingly this menu gives access to the in-built help dialogues.
- *Quit*: guess!
- *File*: the menu for loading and saving filter specifications and for printing screen dumps.
- *Model*: the menu for selecting the type of filter (i.e. lowpass, highpass, etc.).
- *Type*: is a click-selectable box for selecting Passive or Active filter types.
- *X-Scale*: this box selects either linear or logarithmic scaling of the spectrum display.

At the bottom of the screen are the user-selectable parameters:

L.Stop; L.Pass; U.Pass; U.Stop; Zsource; Zload, Attn and Ripple for Band pass filters. For bandstop filters exchange the Pass with Stop and vice versa. For lowpass filters the L.* items are obviously not available and for highpass the H.* items are not. These parameters are the basic design tools for the filter. By setting the various frequencies for *Lower*.Stop and Pass, *Upper*.Stop and Pass, Z source and load *impedance*, *Attenuation* and *Ripple* the entire specification of the filter is entered.

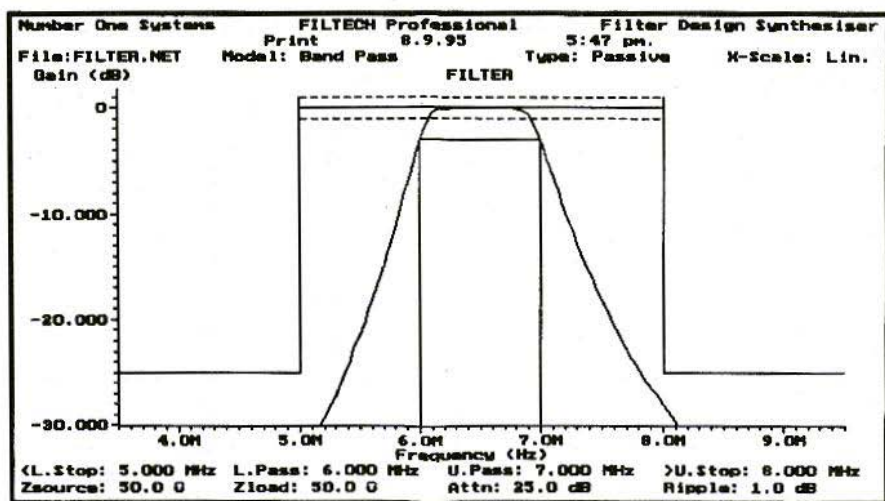

Fig.2: Filter Response Plot

The design screen, as described earlier, is essentially a graph on which the spectrum of the filter is plotted. The design screen has on it graticule lines representing the frequency limits, attenuation and ripple characteristics as determined by the user-selectable parameters. As these selectable parameters are changed so the screen display graticule alters in accordance with the values entered.

Once the filter specifications have been entered then a simple click on the View menu sets the simulation package into motion. Upon completion of the simulation a plot of the filter is printed onto the screen (Fig.2). If the design is not quite as it should be then any of the parameters can be altered and the simulation rerun, which can be repeated until the spectrum meets the specification.

However, there is a problem with systems that use mathematical analysis to solve a problem rather than the

empirical method as I have used in the past described at the beginning of this review. The problem is that the science can be too exact, per se: components end up having values such as 2.36947 or 3.68956229pF - not exactly what one would call helpful in the world of the Exx ranges of components generally available! Fear not, the answer is at hand. A feature within the *File* menu called *Overlay Preferred* is the solution to this problem. By selecting this item, a sub menu appears giving the choice of selecting preferred value series for the resistors, capacitor and inductors, or the choice of leaving the values as *True Value*, that is the values as calculated by *Filtech*.

Having selected the required preferred ranges for the components then a press of the *Escape* key closes the menu and automatically reruns the simulation. The resulting spectrum is plotted on the screen in red leaving the original plot viewable (Fig.3), so that not only can

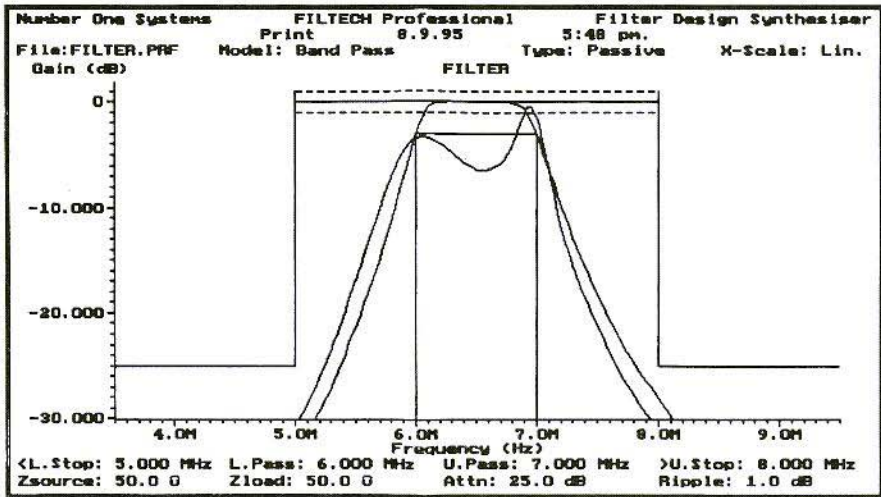

Fig.3: Plot Corrected for Preferred Component Values

the plot be compared with the selected parameters but it can also be compared with the original mathematical plot.

Now that we have fine tuned our filter design it is time to commit this theoretical device to a practical buildable unit. To do this you once again select the *File* menu and from it select *Print the Netlist*, which results in a printout similar to Fig.4. Now what do you do? Refer to Appendix D is the answer. *Filtech* simulates filters on the basis of pre-defined circuit modules, the circuits of which are shown in Appendix D. To build a filter you refer to the filter tables in the Appendix which show which groups of modules are connected together for a particular design. From Fig.4 it can be seen that the filter designed is a 4th order passive bandpass Chebychev type. By reference to the tables in the handbook the necessary circuit modules are selected. The component references and values shown on the Netlist (Fig.4) are then simply

transferred to the circuit elements and there is your filter.

4. CONCLUSIONS

Although I am not a design engineer but just a plain ordinary electronics engineer, I am an active radio amateur, and as such I do need to design the odd filter or two for specific applications. Thus I am conversant with the basics of filter design, however, faced with the power and versatility of *Filtech* I was able to design complex filters with but a few key presses. The ability to simulate the filter and see the results of any changes to the parameters makes the entire task a pleasure.

This software system lives up to the pedigree of the previous Number One



Circuit: C:\FILPRO\FILTER.NET

```

Source Impedance : 50.0 Ohms
Load Impedance  : 50.0 Ohms
Filter Model     : Passive Band Pass (N)
Lower Stop Freq. : 5.000 MHz
Lower Pass Freq. : 6.000 MHz
Upper Pass Freq. : 7.000 MHz
Upper Stop Freq. : 8.000 MHz

Filter Design    : Chebyshev
Maximum Ripple  : 0.01 dB
Filter Order     : 3

Reference: R#      Component: R
A=IN              B=1
R:50.000

Reference: C1      Component: C
A=1               B=2
C:64.160pF

Reference: L1      Component: L
A=2               B=3
L:9.399uH

Reference: C2      Component: C
A=3               B=COMMON
C:5.798nF

Reference: L2      Component: L
A=3               B=COMMON
L:104.025nH

Reference: C3      Component: C
A=3               B=4
C:64.160pF

Reference: L3      Component: L
A=4               B=OUT
L:9.399uH

Reference: R999    Component: R
A=OUT            B=COMMON
R:50.000

```

Fig.4: The Component Net List

Systems packages that I have reviewed and used in the past. Simplicity of operation with a well-defined graphical user interface makes the software easy to use with a fast learning curve. The handbook is concise, but detailed enough to explain all of the facilities of the package.

Within a short while I was running the software with ease and felt able to design very complex filters without the need to know more than the basic specifications. As with the rest of the range of Number One Systems simulation and design software, the time saving aspects of such a package must be extremely desirable to the design engineer as well as perhaps even the casual user.

I am not able to think of anything that I did not like about the software. There

are one or two idiosyncrasies which a dedicated Windows user (me!) found a little odd. Namely, each of the drop-down menus has a *Leave the Menu* option, somewhat unnecessary as the usual press of the escape key results in the same action! It appears not to be possible to expand the Help screen to full size, but it remains a small dialogue box - again odd for a Windows user. But these are nit-picking things, as far as the software itself is concerned I can certainly recommend it as a development aid. Not only will it save lots of design time in mathematical analysis, it will possibly save much prototype manufacturing time as well. A necessary addition to the development tools of any electronic design laboratory.

Filtech and *Filtech Professional* are available from Number One Systems Ltd., Harding Way, St.Ives, Huntingdon, Cambridgeshire, PE17 4WR, UK. Tel: (0)1480 461778; Fax: (0) 1480 494042.

The software is also available from KM Publications, 5 Ware Orchard, Barby, Nr.Rugby, CV23 8UF, UK. Tel: (0)1788 890365; Fax: (0)1788 891883.

The prices are for *Filtech* £145.00 +£7.50 p&p + VAT and for *Filtech Professional* £245.00 +£7.50 p&p + VAT.

MS-DOS, *Windows 3* and *3.1*, *Windows for Workgroups 3.11* and *Windows 95* are registered trade marks of the Microsoft Corporation. *Laserjet* is a registered trade mark of Hewlett-Packard. *Analysar III* is a registered trade mark of Number One Systems Ltd.



COMPLETE KITS

for projects featured in VHF Communications

KIT	DESCRIPTION	ISSUE	ART No	PRICE
DB1NV-006	Spectrum Analyser IF Amplifier	2/89	06370	£142.00
DB1NV-007	Spectrum Analyser Lo-PLL	2/89	06371	£ 62.00
DB1NV-008	Spectrum Analyser Crystal Filter	3/89	06372	£108.00
DB1NV-009	Spectrum Analyser Sweep Gen	3/89	06373	£ 48.00
DB1NV-010	Spectrum Analyser Digital Store	3&4/91	06378	£132.00
DB1NV-011	Spectrum Analyser Tracking Gen	2/92	06474	£143.00
DB1NV-012	Spectrum Analyser VCO 1450 MHz	4/92	06483	£ 39.00
DB1NV-013	Spectrum Analyser VCO 1900 MHz	4/92	06484	£ 41.00
DB6NT-001	Measuring Amp up to 2.5 GHz	4/93	06382	£ 60.00
DB6NT-002	Frequency Divider to 5.5 GHz	4/93	06383	£100.00
DJ8ES-001	23cm FM ATV Converter	1/91	06347	£ 93.00
DJ8ES-002	Digital Frequency Indicator	1/91	06352	£ 53.00
DJ8ES-003	IF Amplifier	1/91	06355	£ 55.00
DJ8ES-004	Demodulator	1/91	06362	£ 72.00
DJ8ES-019	Transverter 144/28 MHz	4/93	06385	£143.00
DJ8ES-019mod	Transverter 50/28 MHz	2/95	06392	£143.00
DJ8ES-020	Hybrid Amplifier for 144 MHz	1/94	06387	£179.00
DJ8ES-021	13cm FM ATV Exciter	2/94	06388	£ 67.00
DJ8ES-022	28/432 MHz Transverter Oscillator	2/95	06395	£ 59.00
DJ8ES-023	28/432 MHz Transverter Converter	2/95	06396	£114.00
DC8UG-007	5W PA for 13cm	3/94	06938	£286.00

Minimum postage and packing charge is £6.75. Credit Card orders +5%.

KM Publications, 5 Ware Orchard, Barby, Nr.Rugby, CV23 8UF, U.K.

Tel: (0)1788 890365

Fax: (0)1788 891883



KITS and PRINTED CIRCUIT BOARDS

for the Matjaz Vidmar GPS/GLONASS Receiver project

KITS

Name	Issue	Description	Art.No	Price
S53MV001	1/95	GPS RF Module	06491	£ 24.35
S53MV002/003	1/95	GPS Converter, Multiplier & Mixer	06493	£ 62.95
S53MV004	1/95	GLONASS RF Module	06494	£ 29.65
S53MV005	1/95	GLONASS IF Converter	06496	£ 43.95
S53MV006	1/95	GLONASS PLL Synth. Converter	06498	£ 19.15
S53MV007	2/95	GLONASS Synthesiser	06500	£ 22.95
S53MV008	2/95	GPS/GLONASS Second IF	06502	£ 14.40
S53MV009	2/95	GPS/GLONASS DSP Module	06504	£ 75.40
S53MV010	3/95	GPS/GLONASS CPU Board	06547	£ 194.55
S53MV011	3/95	GPS/GLONASS 8-key Keyboard	06549	£ 34.90
S53MV013	3/95	GPS/GLONASS PSU and Reset	06553	£ 20.60
BSGPS		Complete GPS Kit	06555	£ 410.00
BSGLONASS		Complete GLONASS Kit	06556	£ 425.00

PC BOARDS

Name	Issue	Description	Art.No	Price
S53MV001	1/95	GPS RF Module	06490	£ 9.60
S53MV002/003	1/95	GPS Converter, Multiplier & Mixer	06492	£ 10.05
S53MV004	1/95	GLONASS RF Module	06495	£ 9.60
S53MV005	1/95	GLONASS IF Converter	06497	£ 10.05
S53MV006	1/95	GLONASS PLL Synth. Converter	06499	£ 19.15
S53MV007	2/95	GLONASS Synthesiser	06501	£ 22.95
S53MV008	2/95	GPS/GLONASS Second IF	06503	£ 6.25
S53MV009	2/95	GPS/GLONASS DSP Module	06505	£ 25.80
S53MV010	3/95	GPS/GLONASS CPU Board	06548	£ 25.80
S53MV011	3/95	GPS/GLONASS 8-key Keyboard	06550	£ 6.75
S53MV013	3/95	GPS/GLONASS PSU and Reset	06554	£ 8.65
LPGPS		Complete set of GPS Boards	06557	£ 83.10
LPGLONASS		Complete set of GLONASS Boards	06558	£ 124.75

Minimum postage and packing charge is £6.75. Credit Card orders +5%.

KM Publications, 5 Ware Orchard, Barby, Nr.Rugby, CV23 8UF, U.K.

Tel: (0)1788 890365

Fax: (0)1788 891883

**PRINTED CIRCUIT BOARDS****for projects featured in VHF Communications**

DB1NV	Spectrum Analyser			Art No.
PCB	DB1NV-006	IF Amplifier	Ed.2/89	06997 £ 17.25
PCB	DB1NV-007	Lo-PLL	Ed.2/89	06995 £ 17.25
PCB	DB1NV-008	Crystal Filter	Ed.3/89	06998 £ 17.25
PCB	DB1NV-009	Sweep Generator	Ed.3/89	06996 £ 17.25
PCB	DB1NV-010	Digital Store	Ed.3&4/91	06477 £ 21.15
PCB	DB1NV-011	Tracking Generator	Ed.2/92	06479 £ 15.50
PCB	DB1NV-012	VCO 1450 MHz	Ed.4/92	06480 £ 16.35
PCB	DB1NV-013	VCO 1900 MHz	Ed.4/92	06481 £ 16.35
DB6NT	Measuring Aids for UHF Amateurs			Art No. ED. 4/93
PCB	DB6NT-001	Measuring Amp up to 2.5 GHz		06379 £ 17.75
PCB	DB6NT-002	Frequency Divider to 5.5 GHz		06381 £ 17.75
DJ8ES	23cm FM-ATV Receiver			Art No. ED. 1/91
PCB	DJ8ES-001	Converter		06347 £ 10.75
PCB	DJ8ES-002	Digital Frequency Indicator		06350 £ 9.65
PCB	DJ8ES-003	IF Amplifier		06353 £ 7.95
PCB	DJ8ES-004	Demodulator		06356 £ 10.30
DJ8ES	28/144 MHz Transverter			Art No. ED. 4/93
PCB	DJ8ES-019	Transverter 144/28 MHz		06384 £ 17.75
PCB	DJ8ES-020	Hybrid Amplifier 144 MHz		06386 £ 17.25
DF9PL	High Stability Low Noise PSU			Art No. ED. 1/93
PCB	DF9PL-001	30 Volt PSU		06378 £ 9.80
PCB	DF9PL-002	Pre-Stabiliser		06376 £ 10.20
PCB	DF9PL-003	Precision Stabiliser		06377 £ 11.20
F6IWF	10 GHz FM ATV Transmitter			Art No. ED. 2/92
PCB	F6IWF-001	DRO Oscillator - PTFE		06485 £ 16.20
PCB	F6IWF-002	Modulator and Stabiliser		06486 £ 12.00
DC8UG	13cm GaAsFET PA			Art No. ED. 3/94
PCB	DC8UG-PA	5W PA for 13cm		06936 £ 19.25
PCB	DC8UG-NT	Power Supply for the PA		06937 £ 7.75

Minimum postage and packing charge is £6.75. Credit Card orders +5%.

KM Publications, 5 Ware Orchard, Barby, Nr.Rugby, CV23 8UF, U.K.

Tel: (0)1788 890365

Fax: (0)1788 891883



VHF COMMUNICATIONS

A Publication for the Radio Amateur Worldwide

Especially Covering VHF, UHF and Microwaves

Volume No. 28 . Spring . Edition 1/1996

Publishers

KM PUBLICATIONS,
5 Ware Orchard, Barby, Nr.Rugby,
CV23 8UF, United Kingdom
Tel: 01788 890365
Fax: 01788 891883

Internet:
vhf-comm@g6iqm.demon.co.uk
CompuServe: 100441,377

Editor

Mike Wooding G6IQM

**VHF
COMMUNICATIONS**

The international edition of the German publication UKW-Berichte is a quarterly amateur radio magazine, especially catering for the VHF/UHF/SHF technology. It is owned and published in the United Kingdom in Spring, Summer, Autumn and Winter by KM PUBLICATIONS.

The 1996 subscription price is £16.00, or national equivalent. Individual copies are available at £4.50, or national equivalent each. Subscriptions should be addressed to the national representative shown in the next column. Orders for individual copies of the magazine, back issues, kits, binders, or any other enquiries should be addressed directly to the publishers.

NOTICE: No guarantee is given that the circuits, plans and PCB designs published are free of intellectual property rights. Commercial supply of these designs without the agreement of the Author and Publisher is not allowed. Users should also take notice of all relevant laws and regulations when designing, constructing and operating radio devices.

© KM
PUBLICATIONS

All rights reserved. Reprints, translations, or extracts only with the written approval of the publishers

Translated by: Inter-Ling Services,
62 Caldecott Street, Rugby,
CV21 3TH, UK

Printed in the United Kingdom by:
Cramphorn Colour Printers Ltd.,
15c Paynes Lane, Rugby.

AUSTRIA - Verlag UKW-BERICHTE, Terry D. Bittan, POB 80,
D-91081 BAIERSDORF, Germany. Tel: (9133) 47-0
Fax: 09733 4747 Telex: 629 887, Postgiro Nbg. 30445-858.

AUSTRALIA - W.I.A., P.O. Box 300, SOUTH CAULFIELD,
3162 VIC, Australia. Tel: 528 9962

BELGIUM - UKW-BERICHTE, POB 80, D-91081 BAIERSDORF,
Germany. Tel: (9133) 47-0. Fax: 09733 4747 Telex: 629 887,
Postgiro Nbg. 30445-858.

DENMARK - KM PUBLICATIONS, 5 Ware Orchard, Barby,
Nr.RUGBY, CV23 8UF, UK. Tel: +44 788 890365,
Fax: +44 788 891883. Email: vhf-comm@g6iqm.demon.co.uk

FRANCE - Christiane Michel F5SM, SM ELECTRONIC, 20bis
Avenue des Clairons, F-89000 AUXERRE, France
Tel: (86) 46 96 59

FINLAND - KM PUBLICATIONS, 5 Ware Orchard, Barby,
Nr.RUGBY, CV23 8UF, UK. Tel: +44 788 890365,
Fax: +44 788 891883. Email: vhf-comm@g6iqm.demon.co.uk

GERMANY - UKW-BERICHTE, POB 80, D-91081
BAIERSDORF, Germany. Tel: (9133) 7798 0.
Fax: 09133 779833, Postgiro Nbg. 30445-858.

GREECE - C+A ELECTRONIC, P.O. Box 25070, ATHENS
100 26, Greece. Tel: 01 52 42 867. Fax: 01 52 42 537

HOLLAND - KM PUBLICATIONS, 5 Ware Orchard, Barby,
Nr.RUGBY, CV23 8UF, UK. Tel: +44 788 890365,
Fax: +44 788 891883. Email: vhf-comm@g6iqm.demon.co.uk

ITALY - ADB ELETTRONICA di Luchesa Fabrizio IW5ADB,
Via Vecchia Romana 266, 55100 ANTRACCOLI, (LUCCA), Italy.
Tel: 0583 952612. Fax: 0583 91109

NEW ZEALAND - Judith Holland, AUCKLAND VHF GROUP
Inc., P.O. Box 10 138, AUCKLAND 1030, New Zealand.
Tel: 0 9 412 7659

NORWAY - TIENNING THEG RADIO COMMUNICATION
LA4YG, Kjøpveien 30, 1370 ASKER, Norway.
Postgirokontor: 3 16 00 09

SOUTH AFRICA - III-TECH BOOKS, P.O. Box 1142,
RANDBURG, Transvaal 2125, South Africa. Tel: (011) 465 3385

SPAIN & PORTUGAL - JULIO A. PRIETO ALONSO EA4CJ,
Donoso Cortes 58 5^a -B, MADRID 15, Spain. Tel: 543 83 84

SWEDEN - WAVELINE AB, Box 60224, S-210911 MALMÖ,
Sweden. Tel: 40 16 42 66. Fax: 40 15 05 07. GSM: 0705 16 42 66
Postgiro: 13 78 93 - 4

SWITZERLAND - KM PUBLICATIONS, 5 Ware Orchard, Barby,
Nr.RUGBY, CV23 8UF, UK. Tel: +44 788 890365,
Fax: +44 788 891883. Email: vhf-comm@g6iqm.demon.co.uk

UNITED KINGDOM - KM PUBLICATIONS, 5 Ware Orchard,
Barby, Nr.RUGBY, CV23 8UF, UK. Tel: +44 788 890365,
Fax: +44 788 891883. Email: vhf-comm@g6iqm.demon.co.uk

U.S.A. - WYMAN RESEARCH Inc., RR#1 Box 95, WALDRON,
Indiana 46182, U.S.A. Tel: (317) 525 6452

- Henry Ruh, ATVQ MAGAZINE, 3 North Court Street,
Crown Point, Indiana 46307, U.S.A. Tel: (219) 662 6395.
Fax: (219) 662 6991

ELSEWHERE - KM PUBLICATIONS, address as for the U.K.

WWW: <http://www.eolas.co.uk/jag/vhfcomm.htm>

ISSN 0177-7505

EASY-PC, Schematic and PCB CAD

Over 19,000 Installations
in 80 Countries World-wide!

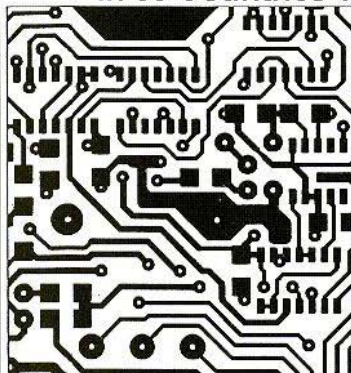

- Runs on:- PC/XT/AT/ 286/ 386/ 486 with Hercules, CGA, EGA or VGA display and many DOS emulations.
- Design:- Single sided, Double sided and Multi-layer (8) boards.
- Provides full Surface Mount support.
- Standard output includes Dot Matrix / Laser / Ink-jet Printer, Pen Plotter, Photo-plotter and N.C. Drill.
- Tech Support - free.
- Superbly easy to use.

Now
Only
£75.00!
Plus P&P+VAT

BRITISH
DESIGN
AWARD
1989

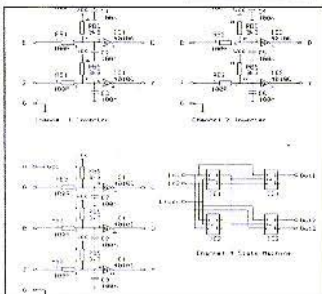

Options:-500 piece Surface Mount Symbol Library £48,
1000 piece Symbol Library £38, Gerber Import facility £98.

Electronic Designs Right First Time?

LAYAN - Electro-magnetic Simulation ONLY £495

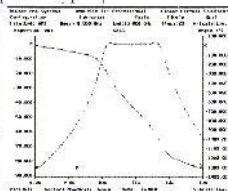
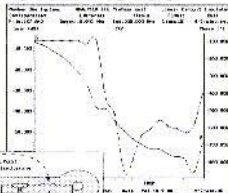
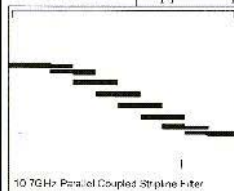
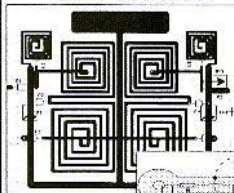

Affordable Electronics CAD

EASY-PC Professional: Schematic Capture and PCB CAD. Links directly to ANALYSER III, LAYAN and PULSAR.	From \$275	£145
MultiRouter: 32bit Multi-pass Autorouter	\$575	£295
LAYAN: New Electro-Magnetic layout Simulator. Include board parasitics in your Analogue simulations. Links with and requires EASY-PC Professional XM and ANALYSER III Professional	\$950	£495
PULSAR: Digital Circuit Simulator	From \$195	£98
ANALYSER III: Analogue Linear Circuit Simulator	From \$195	£98
FILTECH: Active and Passive Filter Design program	From \$275	£145
STOCKIT: New comprehensive Stock control program for the small or medium sized business	\$275	£145
EASY-PC: Entry level PCB and Schematic CAD.	\$145	£75
Z-MATCH: Windows based Smith-Chart program for RF Engineers	From \$275	£145

We operate a no penalty upgrade policy.
US\$ prices include Post and Packing
Sterling Prices exclude P&P and VAT.

For full information, please write, phone or fax:-

Number One Systems

UK/EEC: Ref. VHF.COM, Harding Way, St Ives, Cambridgeshire., ENGLAND, PE17 4WR.
Telephone UK: 01480 461778 (7 lines) Fax: 01480 494042
USA: Ref. VHF.COM, 126 Smith Creek Drive, Los Gatos, CA 95030
Telephone/Fax: (415) 968-9306

e-mail: sales@numberone.com
International +44 1480 461778



- TECHNICAL SUPPORT FREE FOR LIFE
- PROGRAMS NOT COPY PROTECTED.
- SPECIAL PRICES FOR EDUCATION.